

AM/FM STEREO RECEIVER

SX-550

SERVICE MANUAL



 PIONEER®

CONTENTS

1.	SPECIFICATIONS	4
2.	CONNECTION DIAGRAM	6
3.	FRONT PANEL FACILITIES	7
4.	CIRCUIT DESCRIPTIONS	9
5.	BLOCK DIAGRAM	12
6.	LEVEL DIAGRAM	13
7.	DISASSEMBLY	14
8.	DIAL CORD STRINGING	16
9.	ADJUSTING PROCEDURES	
9.1	AM Section	17
9.2	FM Section	18
9.3	MPX Section	19
9.4	Power Amplifier (Idle Current)	20
10.	PARTS LOCATION	
10.1	Front Panel View	21
10.2	Rear Panel View	23
10.3	Top View	25
10.4	Front View	27
11.	EXPLODED VIEWS	
11.1	Exterior	29
11.2	Part 1	31
11.3	Part 2 AF Assembly (AWK-056)	33
11.4	Part 3 RF Assembly (AWE-072)	34
12.	SCHEMATIC DIAGRAMS, P.C. BOARD PATTERNS AND PARTS LISTS	
12.1	Miscellaneous Parts List	36
12.2	Schematic Diagram	37
12.3	RF Assembly (AWE-072-0)	40
12.4	AF Amplifier Assembly (AWK-056)	47
12.5	AF Muting Assembly (AWM-101)	53
13.	PACKING	55
SX-550/KU, HG. S Additional Service Manual		Enclosed Herewith

1. SPECIFICATIONS

Semiconductors

FETs	3
ICs	5
Transistors	28
Diodes	21

Power Amplifier Section

Continuous Power Output from 20 Hertz to 20,000 Hertz
(Both channels driven) . . . 20 watts per channel (8 ohms)

Total Harmonic Distortion (20 Hertz to 20,000 Hertz, from AUX)	
Continuous Rated Power Output	No more than 0.3%
10 watts per channel power output,	
8 ohms	No more than 0.07%
1 watt per channel power output,	
8 ohms.	No more than 0.07%
Intermodulation Distortion (50 Hertz : 7,000 Hertz = 4 : 1, from AUX)	
Continuous Rated Power Output	No more than 0.3%
10 watts per channel power output,	
8 ohms	No more than 0.07%
1 watt per channel power output,	
8 ohms	No more than 0.07%

Damping Factor
(20Hz to 20,000Hz, 8 ohms) 25

Input Sensitivity/Impedance	
PHONO	2.5mV/50k ohms
MIC	7.5mV/50k ohms
AUX	150mV/50k ohms
TAPE PLAY 1	150mV/50k ohms
TAPE PLAY 2	150mV/50k ohms
TAPE PLAY 2 (DIN connector)	150mV/50k ohms

PHONO Overload Level (T.H.D. 0.1%)
 PHONO 200mV (1kHz)

Output Level/Impedance	
TAPE REC 1	150mV
TAPE REC 2	150mV
TAPE REC 2 (DIN connector)	30mV/80k ohms
SPEAKER	A, B, A+B
HEADPHONES.	Low Impedance

Frequency Response	
PHONO (RIAA equalization)	30Hz to 15,000Hz \pm 0.3dB
AUX, TAPE PLAY	10Hz to 60,000Hz \pm 1dB

Tone Control	
BASS	+9dB, -10dB (100Hz)
TREBLE	\pm 8dB (10kHz)

Loudness Contour (Volume control set at -40dB position) +6dB (100Hz), +3dB (10kHz)

2. CONNECTION DIAGRAM

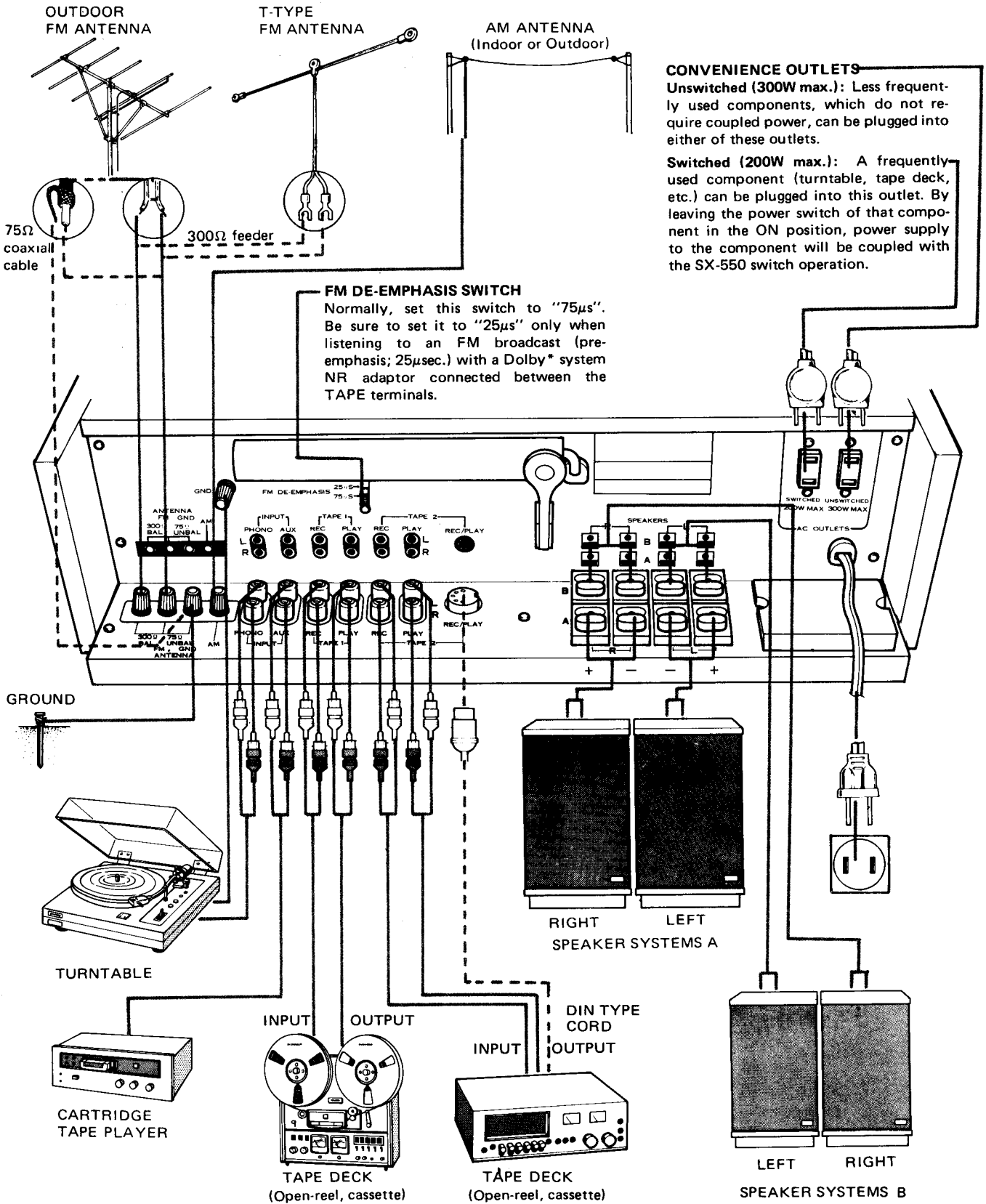

3. FRONT PANEL FACILITIES

SPEAKERS SWITCH (POWER)

A combined power ON/OFF switch and speaker system selector switch.

POWER OFF: Receiver off.

A: To select speakers connected to the A speaker terminals.

OFF: Speakers cut off (headphones can be used).

B: Operates speakers connected to the B speaker terminals.

A+B: To listen simultaneously to speaker systems connected to A and B speaker terminals.

NOTES:

- After turning this switch ON there is a delay of some 7 to 9 seconds, during which time the muting circuit operates to eliminate unpleasant noise.
- For easier operation, plug power cord for turntable, etc. into the switched convenience outlet.

FM STEREO INDICATOR

With the FUNCTION switch set to FM, the STEREO indicator lights while an FM stereo broadcast is being received.

AM/FM TUNING METER

When tuning in FM stations, position the needle in the center FM area for optimum reception. In the case of AM stations, tune for maximum meter deflection toward the right of the scale.

PHONES JACK

To listen through stereo headphones, plug them firmly into this jack.

WARNING:

Do not plug a microphone into the PHONES jack as you may damage the microphone.

BASS & TREBLE CONTROLS

Controls for adjusting the tone. Adjust low frequencies with the BASS control and high frequencies with the TREBLE control.

Turn controls toward the right (MAX) to enhance, and toward the left (MIN) to reduce, their respective frequency ranges.

FM MUTING OFF BUTTON

Leave this button undepressed (in the ON position) to suppress unpleasant interstation noise while tuning between FM stations. Low-strength signals may also be suppressed by this function, so to pick up a weak station depress this button to the OFF position.

MODE SWITCH (MONO)

For stereo playback leave this switch undepressed. When depressed for MONO playback, left and right channel stereo signals will be mixed to produce monophonic sound from both speaker systems.

NOTE:

Recording stereophonically with the MODE switch in the MONO position may cause channel separation to deteriorate.

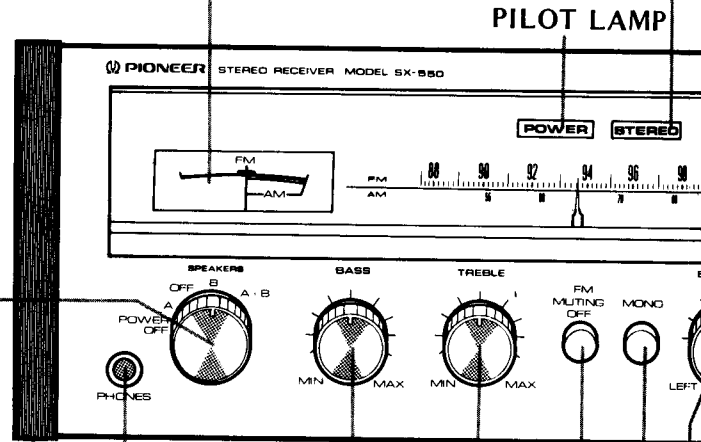

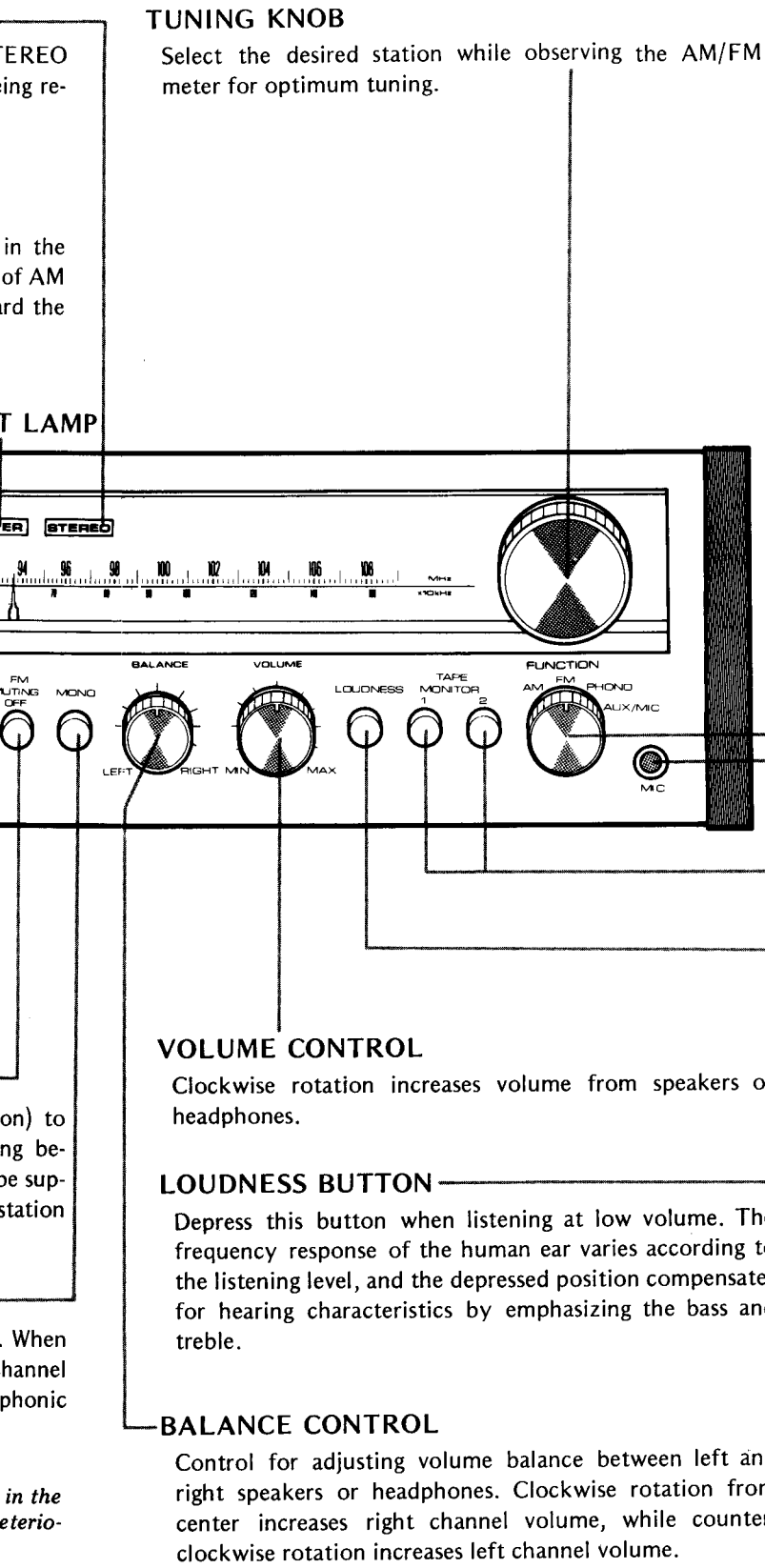

NOTES:

- Leave both of these buttons in the undepressed position when not using tape decks as the sound source. The signal from the source selected by the FUNCTION switch will be interrupted if switches are left in the depressed position.
- When recording with two tape decks simultaneously, do not operate the TAPE MONITOR 1 button as this will interrupt the signal to the TAPE 2 deck.

4. CIRCUIT DESCRIPTIONS

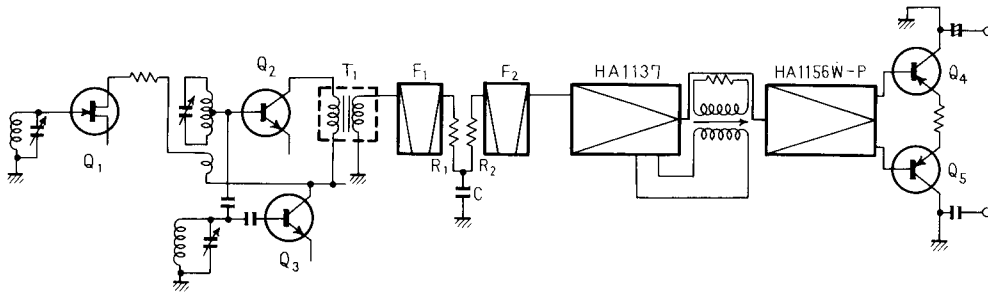

Fig. 1 Tuner Section

TUNER SECTION

FM Front End

A frequency linear 3-gang variable capacitor is used with a single stage FET RF amplifier. The FET possesses high input impedance compared with a transistor, and allows simple coupling with the input tuning circuit, plus a significant advantage in terms of noise.

The local oscillator is a variation of a Clapp circuit and its excellent temperature compensation provides stable frequency even without AFC. Local oscillator voltage is passed through a low value capacitor to the mixer transistor base.

IF Amplifier and Detector

Composed of two dual element ceramic filters and one IC (HA1137). The HA1137 is a high density IC and contains a limiter amplifier, FM detector (quadrature detector), muting, and meter drive circuits.

Multiplex Demodulator

The IC (HA1156W) used in this section does not require a tuning coil and in addition to a PLL stabilized switching signal generator circuit, it contains a double balanced differential amplifier switching system demodulator circuit and an automatic stereo-mono selector circuit. An external switching transistor controlled by the FM muting signal provides automatic monophonic reproduction of input signals below the muting level (FM MUTING switch OFF). The stereo demodulator signal passes through the de-emphasis circuit, then through an amplifier that combines carrier filter and crosstalk canceller to produce the demodulator output.

AM Tuner

Composed of a single IC (HA1138) and dual element ceramic filter. A 2-gang variable capacitor is employed with one stage providing tuning between the antenna and RF amplifier and the other stage tuning the local oscillator. The RF amplifier itself is not tuned but feeds directly to the mixer followed by a 2-stage IF amplifier.

PHONO EQUALIZER AMPLIFIER

IC (TA7136P1) is used with independent left and right channels. Tolerances $\pm 2\%$ styrole capacitors and tolerances $\pm 5\%$ metal oxide resistors comprise the equalizer elements, leading to an RIAA deviation within 0.3dB from 30Hz to 15kHz.

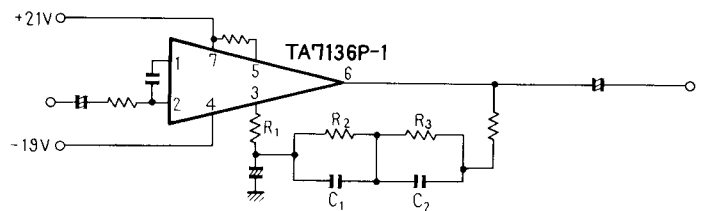

Fig. 2 PHONO Equalizer

MICROPHONE CIRCUIT

A single transistor amplifier (monophonic) is provided in addition to the phono equalizer amplifier. A selector switch cuts the AUX jack input when a plug is inserted into the MIC jack. The amplified microphone signal is then supplied to both the left and right channels. The FUNCTION switch is set to the AUX position when using a microphone.

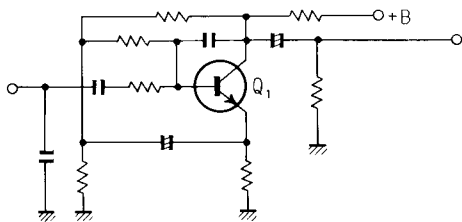

Fig. 3 Microphone Circuit

TONE CONTROL

A CR network tone control circuit is employed in which each attenuator circuit consists of a capacitor and a resistor. These function to increase and decrease the relative levels of low and high frequency sounds. Since relative control over the frequency response by the attenuator results in a constant loss, an amplifier (Q1 & Q2) is used prior to this stage for compensation. The control ranges are +8dB to -8dB for the highs (at 10kHz) and +9dB to -9dB for the lows (at 100Hz).

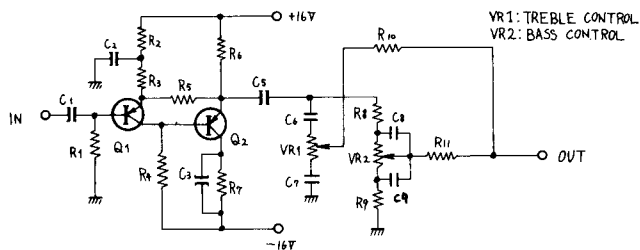

Fig. 4 Tone Control

AF MUTING AMPLIFIER

When the power switch is set to ON, the potential of point C in Fig. 5 instantly rises due to C3 & R5 time constant, and Q4 becomes OFF. Point B potential at this time gradually increases with the C2 & R3 time constant and normally reaches -19V. Q3 becomes OFF when point B is below -15.4V, from which time point A potential rises with the C1 & R1 time constant and normally reaches approximately 8V from R1 & R2. FET Q1 & Q2 operate when point A potential is above 0V. The muting interval (T) extends from the time the power supply is set to ON to when point A potential reaches 0V. This interval is set for 6 ~ 7 seconds.

When the power switch is set to OFF, point C potential instantly becomes -16V. Q4 becomes ON and C2 is immediately discharged. Since this interval is extremely brief, the muting time remains constant even if the power switch is again set to ON.

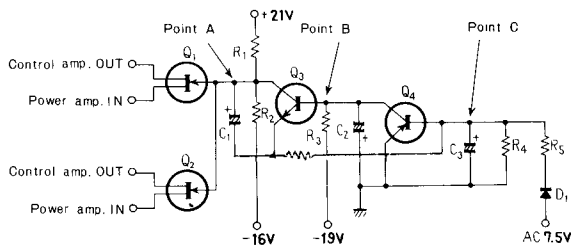

Fig. 5 AF Muting

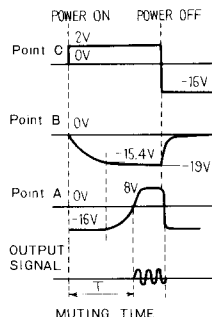

Fig. 6

POWER AMPLIFIER CIRCUIT

Composed of differential first stage, all stages direct coupled pure complementary OCL circuit. Open gain at 1kHz is approximately 80dB and NFB amount is approximately 50dB. R3 and R4 are provided with this circuit in order to obtain adequate stability even with the NFB disconnected. Q1 form a differential amplifier: 100% d.c. feedback is applied from the junction point of the power stage to the base of Q1 so the potential of the junction point is always maintained at the same level.

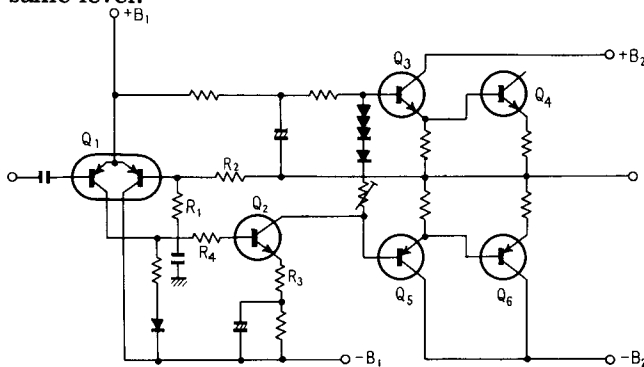

Fig. 7 Power Amplifier

POWER SUPPLY

High stability (ripple cancelling efficiency) is required in the power supply circuit due to its minimized output impedance. In the circuit shown in the Fig. 8, Q1 is controlled by Q2, which detects its output variations. Tuner power is taken from Q3 emitter. Since this is at the power transformer secondary, AC line variations do not directly reach the tuner.

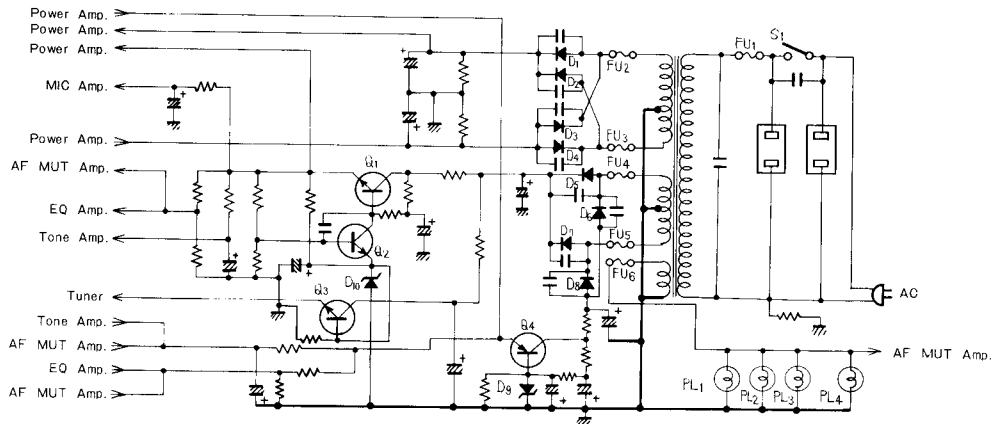
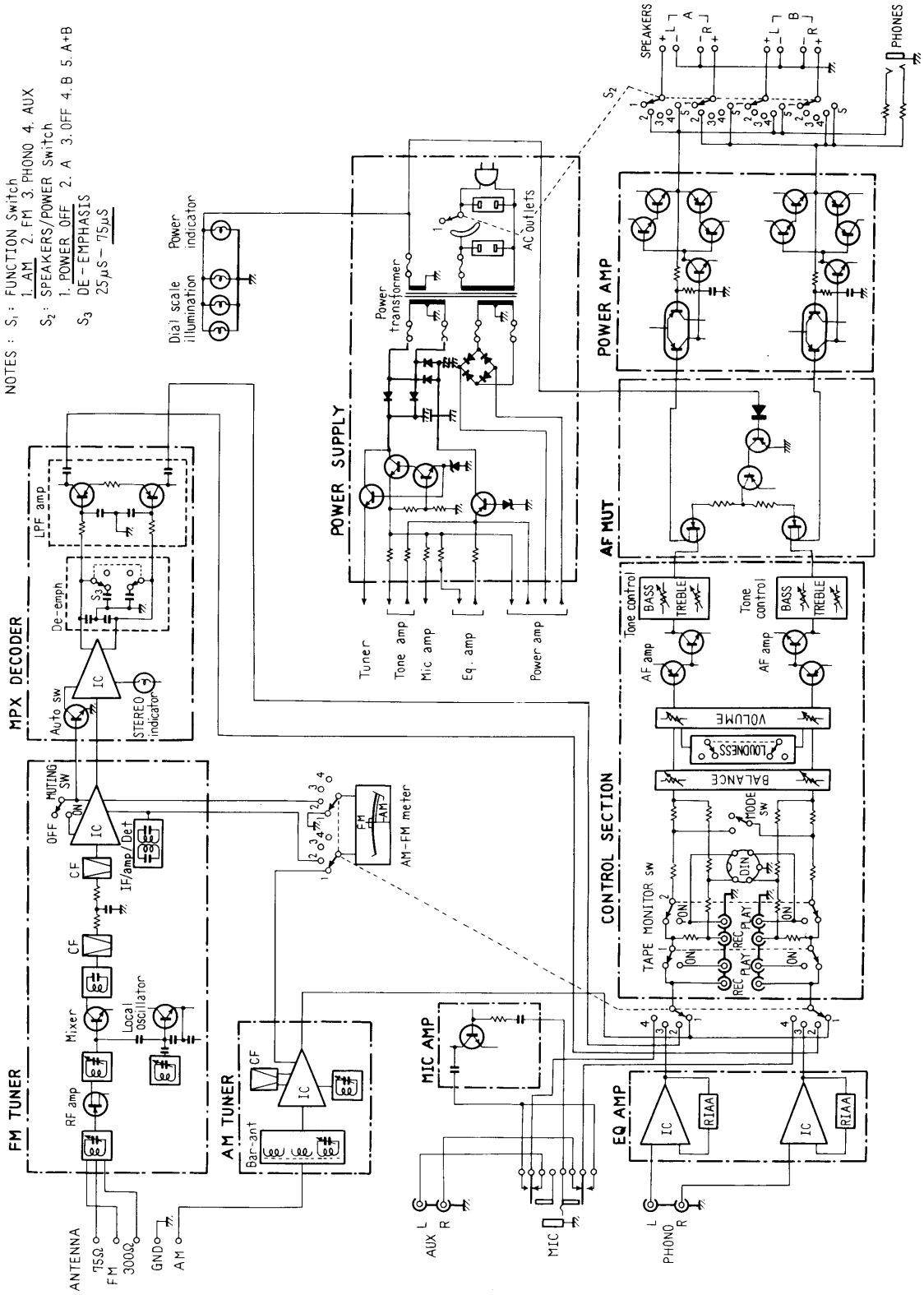

Fig. 8 Power Supply

5. BLOCK DIAGRAM

- NOTES : S₁ : FUNCTION Switch
 1. AM 2. FM 3. PHONO 4. AUX
 S₂ : SPEAKERS/POWER Switch
 1. POWER OFF 2. A 3. OFF 4. B 5. A+B
 S₃ : DE - EMPHASIS
 25 μs - 75 μs



6. LEVEL DIAGRAM

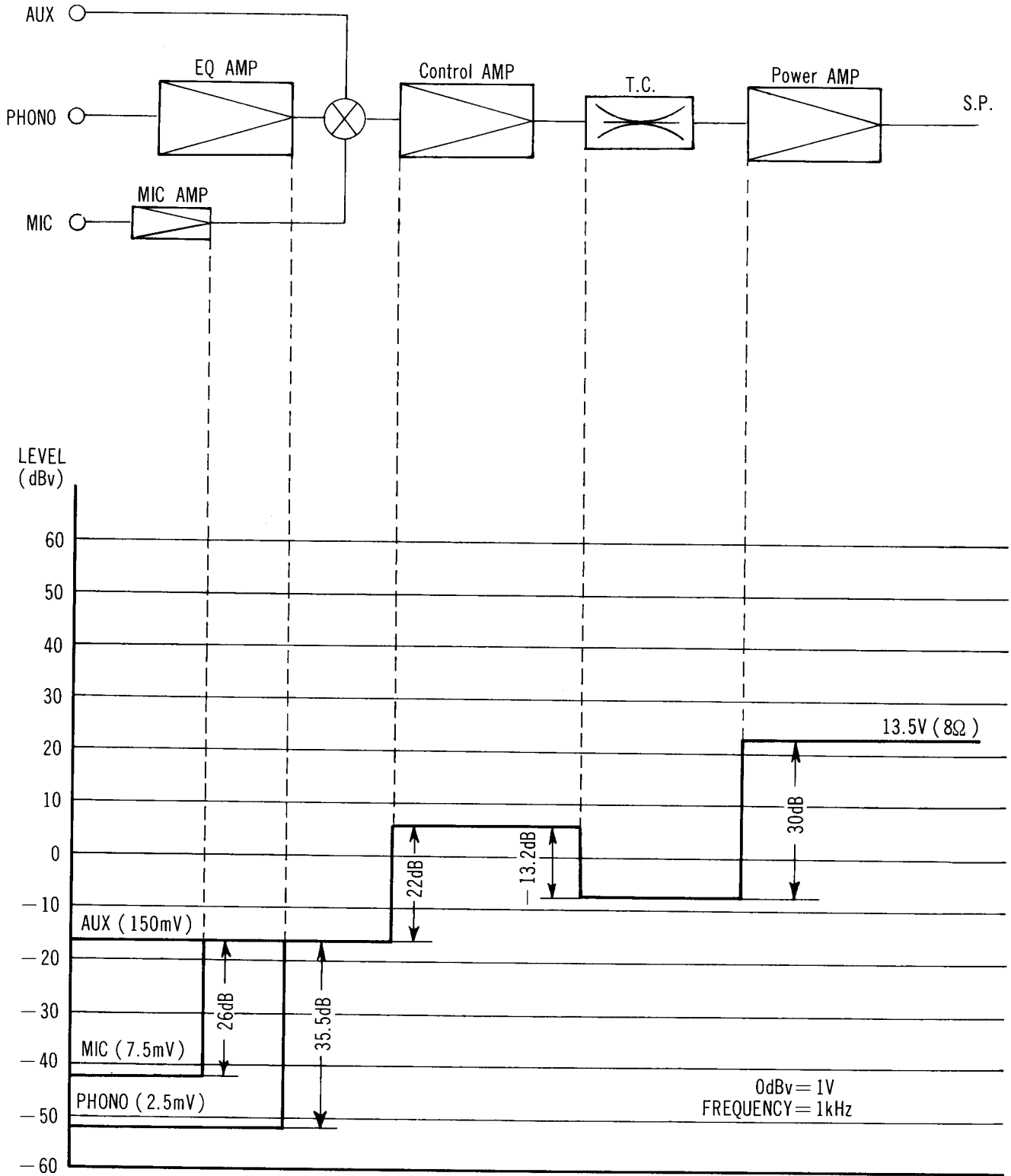

7. DISASSEMBLY

REMOVE SIDE BOARDS

Side board can be removed by taking out 4 screws shown in figure. When reinstalling, observe that space does not occur between them and front panel.

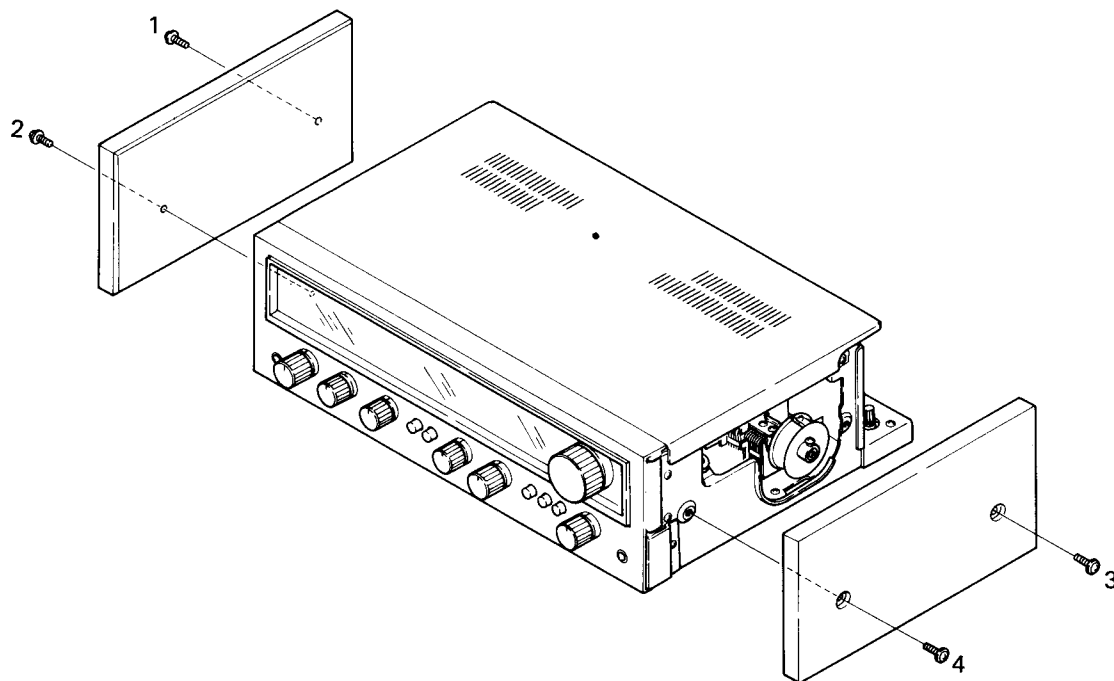

REMOVE TOP PLATE

Take out 2 screws shown in figure to remove.

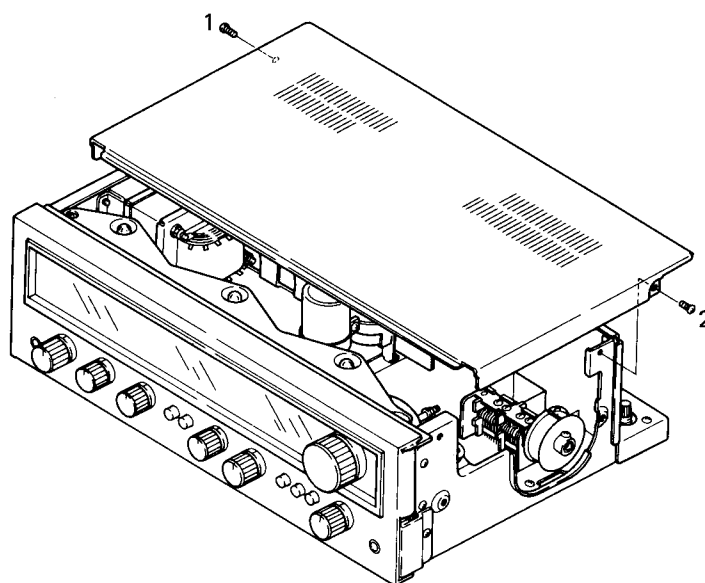

REMOVE BOTTOM PLATE

Take out 8 screws shown in figure and pull rearward to remove.

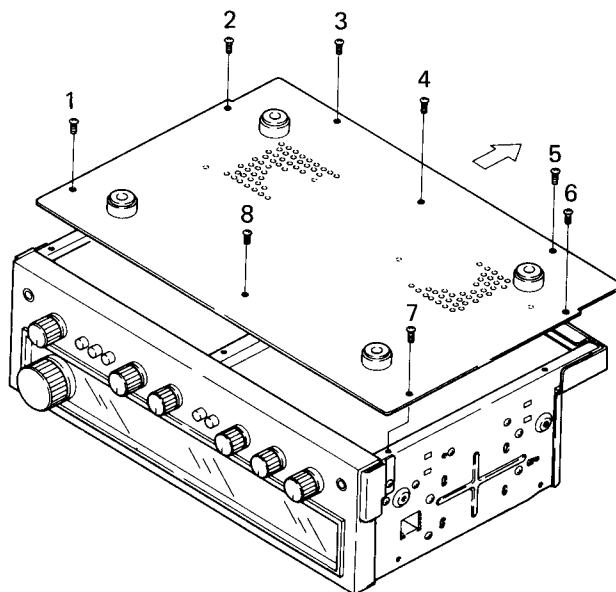

REMOVE FRONT PANEL

Use allen hex wrench to loosen tuning knob set-screw and remove knob. Pull off all knobs (except push buttons), then remove shaft nuts of FUNCTION and SPEAKERS switches. Take out upper left and right screws (2 screws) of front panel and remove.

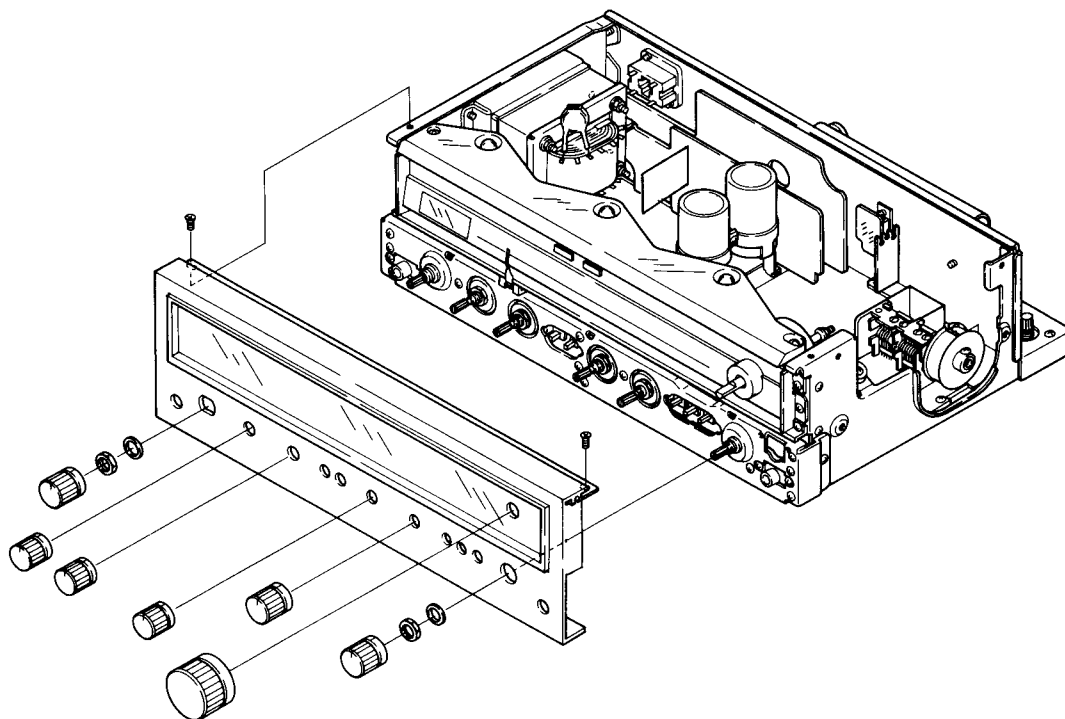

8. DIAL CORD STRINGING

1. Tie end of cord to inner stud of dial pulley.
2. Close tuning capacitor blades fully.
3. Pass cord through dial pulley opening, make a half turn around pulley, then pass in the route: pulley A-dial needle-B-C-dial shaft-D-dial pulley.
4. Wind cord clockwise (as viewed from rear panel) 3 turns around dial shaft, then route to pulley D.
5. Wind 3 turns around dial pulley and tie to spring so that the cord is under tension.
6. Turn TUNING knob and confirm that dial needle moves smoothly.
7. With tuning capacitor blades fully closed, move dial needle to starting point (left edge of scale).
8. Apply lacquer to tied ends of cord.

CAUTION:

Do not touch dial needle with the hand.

Handle dial needle only by the molded portion. Smudges and finger-prints cannot be removed from metallic portion of needle.

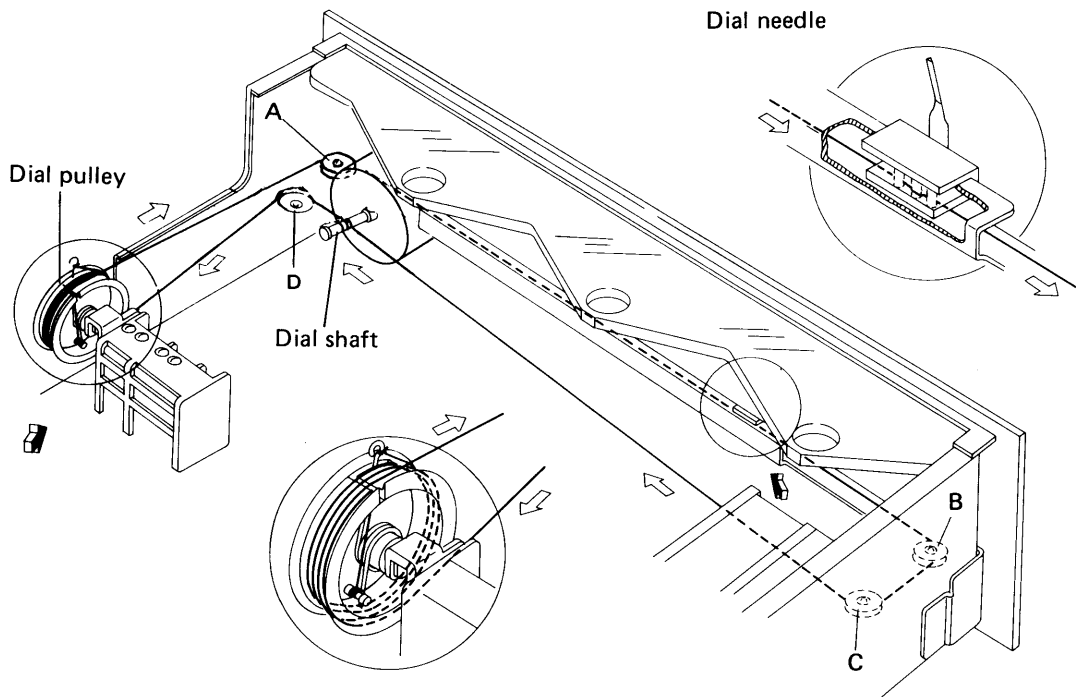

9. ADJUSTING PROCEDURES

9.1 AM SECTION

1. Through a 1k ohm resistor, connect an AM signal generator to the AM antenna terminal. Set for 400Hz at 30dB and 30% modulation.
2. Connect AC VM (Voltmeter) to TAPE REC jack (L or R).
3. Set FUNCTION switch to AM position.
4. Set AM SG and SX-550 dial indication to point A (600kHz).
5. Adjust T6 for maximum indication on AC VM.
6. Set AM SG and SX-550 dial indication to point C (1,400kHz).
7. Adjust TC4 for maximum indication on AC VM.
8. Again set AM SG and SX-550 dial indication to point A.
9. Adjust bar antenna core for maximum indication on AC VM.
10. Return AM SG and SX-550 dial indication to point C.
11. Adjust TC5 for maximum indication on AC VM.
12. Repeat steps 4~11 to eliminate variations in AC VM indications at points A and C.

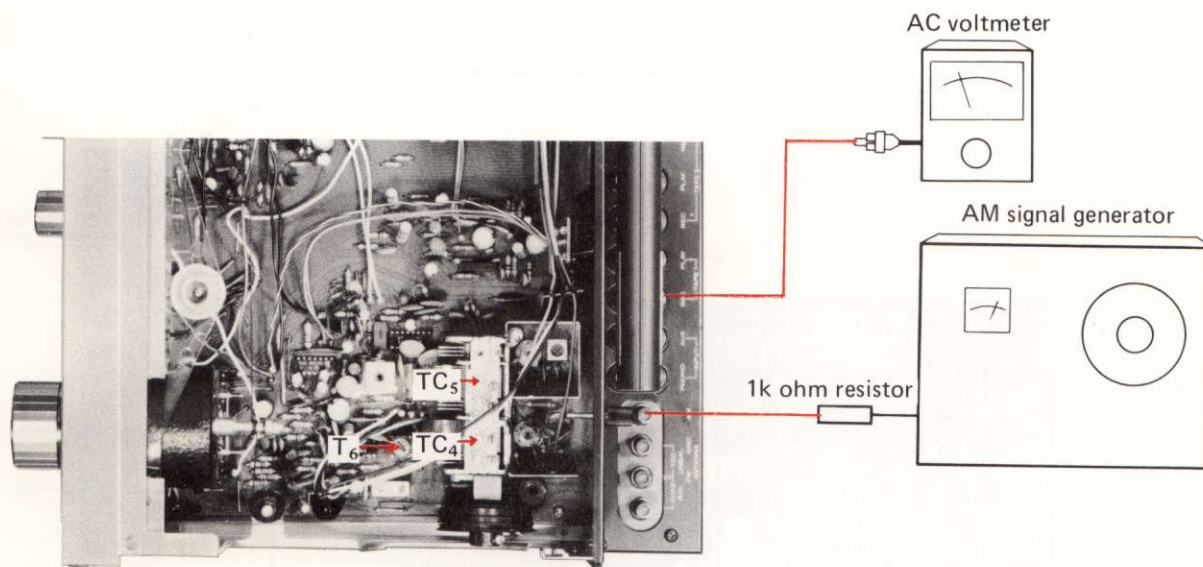

9.2 FM SECTION

1. Through 300 ohm dummy antenna, connect FM signal generator to the 300 ohm FM antenna terminals and set for 400Hz at 100dB and 100% modulation.
2. Connect AC VM and distortion meter to TAPE REC jack (L or R).
3. Set FUNCTION switch to FM and MUTING switch to OFF.
4. Set FM SG and SX-550 dial indication to point A (90MHz).
5. Adjust T3 for maximum indication on AC VM.
6. Adjust T5 lower core for center of scale indication on Tuning meter.
7. Set FM SG for 9dB output and adjust T1 and T2 for maximum indication on AC VM.
8. Set FM SG and SX-550 dial indication to point C (106MHz).
9. Adjust TC3, then TC1 and TC2 for maximum indication on AC VM.
10. Again set FM SG and SX-550 dial indication to point A.
11. Adjust T3, then T1 and T2 for maximum indication on AC VM.
12. Repeat steps 8~11 to eliminate variations in sensitivity at points A and C.
13. Adjust T4 for maximum sensitivity.
14. Detune to noise only and adjust T5 lower core for center of scale indication on Tuning meter.
15. Set SX-550 dial indication to point B (98MHz) and adjust FM SG for center of scale indication on Tuning meter.
16. Set FM SG output to 60dB and adjust T5 upper core for minimum distortion.
17. Repeat steps 14~16 to eliminate variations in minimum distortion position.

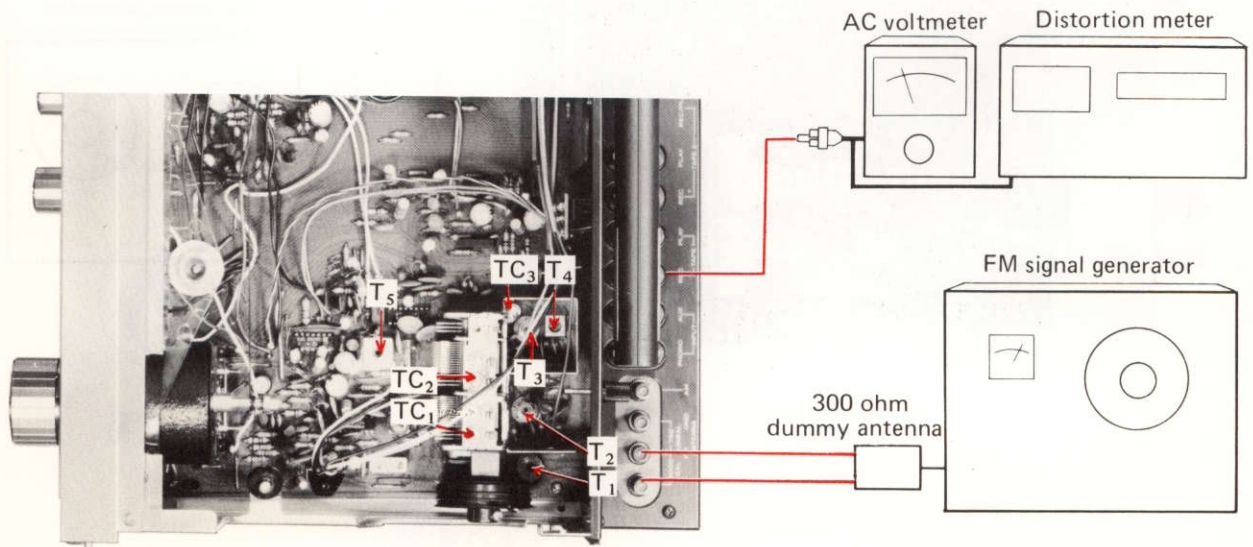

9.3 MPX SECTION

1. Through 300 ohm dummy antenna, connect FM signal generator to 300 ohm FM antenna terminals.
2. Connect multiplex signal generator to external modulation terminals of FM SG.
3. Connect oscilloscope horizontal input to MPX SG pilot output and vertical input via probe to TP (No. 31) of circuit board.

4. Set SX-550 dial indication to 98MHz and adjust FM SG for center of scale indication on Tuning meter.
5. With FM SG unmodulated, adjust VR1 so that lissajous pattern on oscilloscope becomes stationary.
6. With MPX SG modulation 1kHz, L+R 67.5kHz deviation and Pilot 7.5kHz deviation, adjust T4 for minimum distortion.

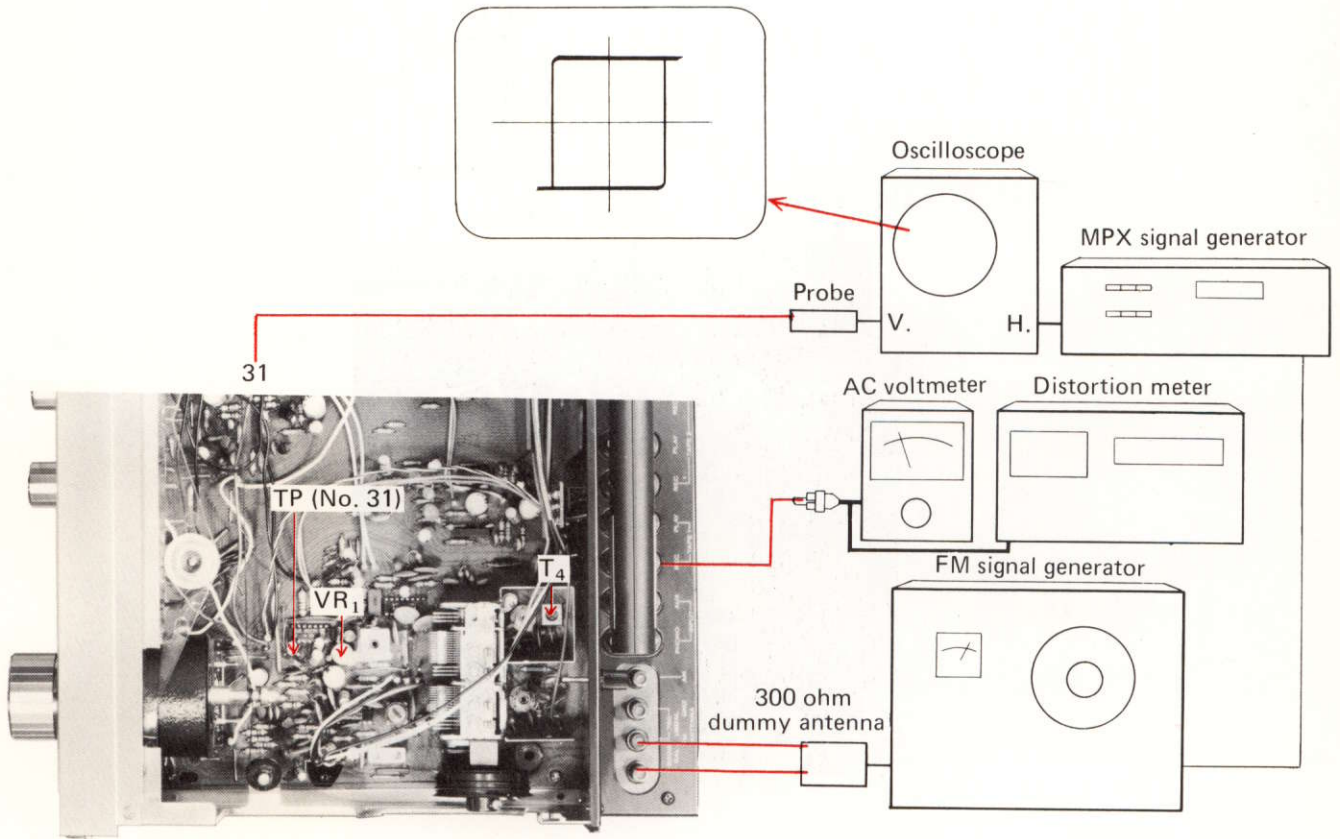

9.4 POWER AMPLIFIER (IDLE CURRENT)

1. Set BASS and TREBLE controls to FLAT positions.
2. Connect DC voltmeter to circuit board TP terminals (L = 34 ⊕, 33 ⊖; R = 35 ⊕, 36 ⊖) and adjust VR3 (L) and VR4 (R) for 25mV.
3. Readjust after approximately 15 minutes (specification range is 15mV to 40mV).

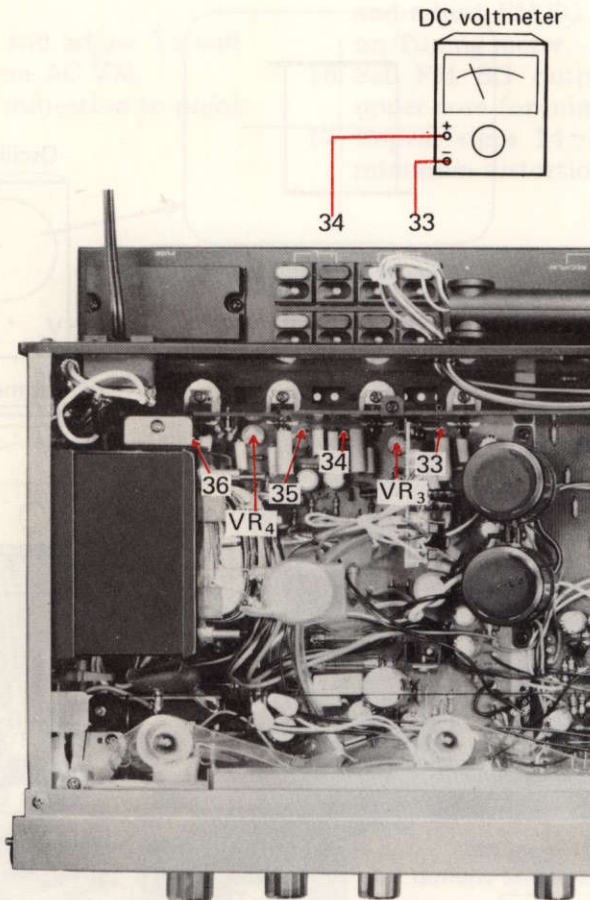

10. PARTS LOCATION

10.1 FRONT PANEL VIEW

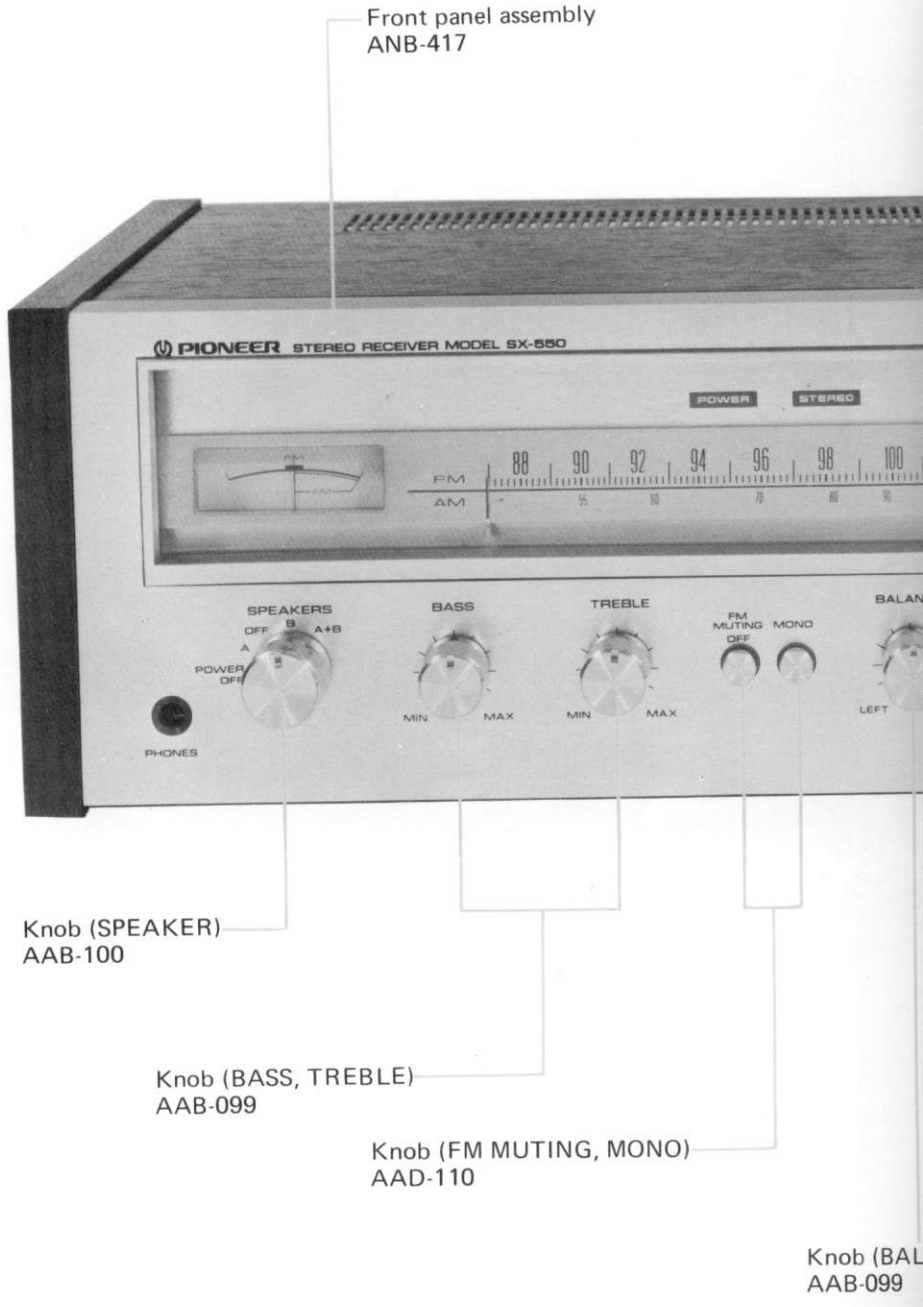



Knob (TUNING)
AAA-036

Knob (BALANCE)
AAB-099

Knob (VOLUME)
AAB-110

Knob (LOUDNESS
TAPE MONITOR 1.2)
AAD-100

Knob (FUNCTION)
AAB-100

10.2 REAR PANEL VIEW



Terminal (ANTENNA)
AKE-028

Terminal 4P
AKB-027

DIN connector socket
(REC/PLAY)
AKP-011

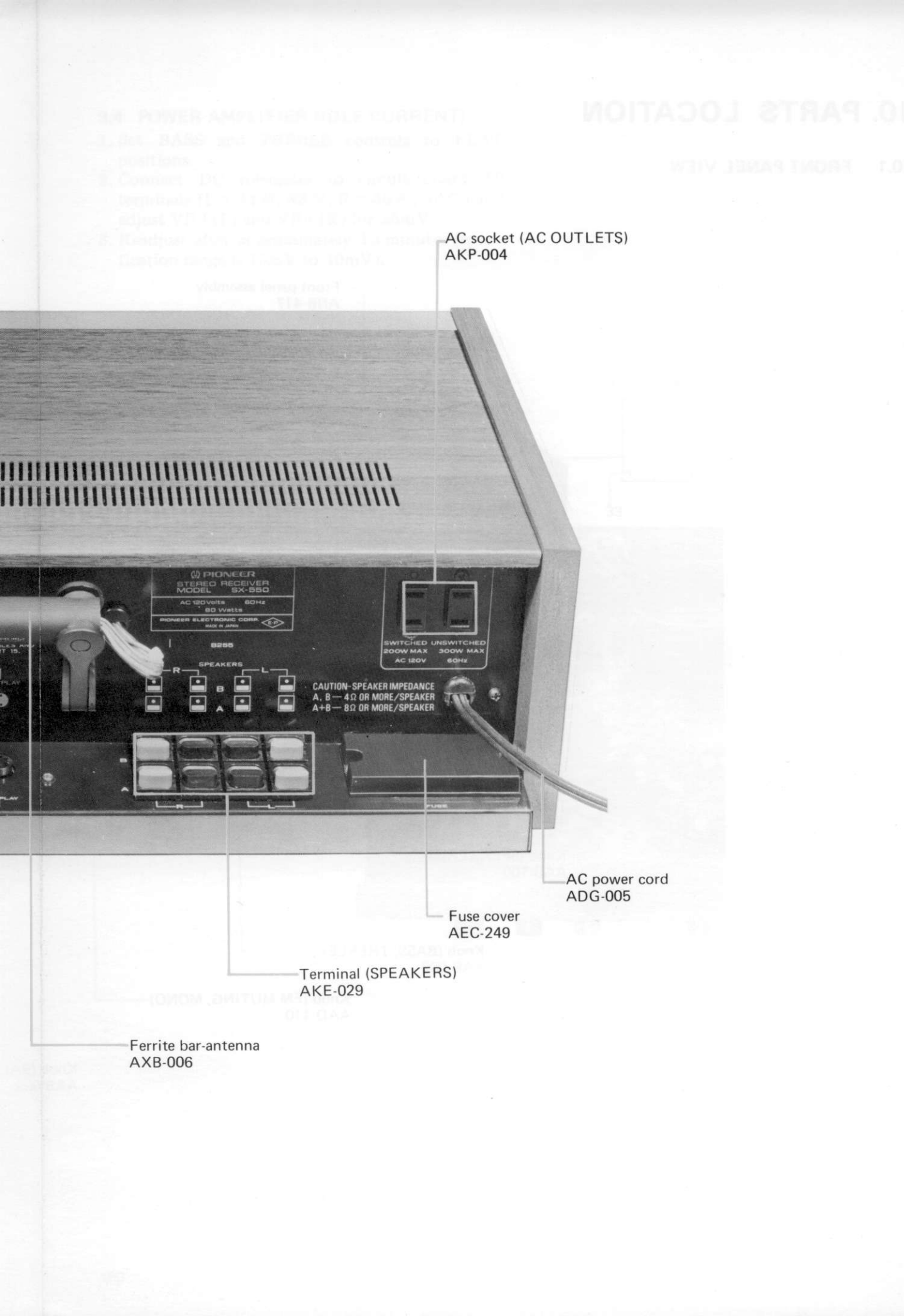

AC socket (AC OUTLETS)
AKP-004

AC power cord
ADG-005

Fuse cover
AEC-249

Terminal (SPEAKERS)
AKE-029

Ferrite bar-antenna
AXB-006

10.3 TOP VIEW

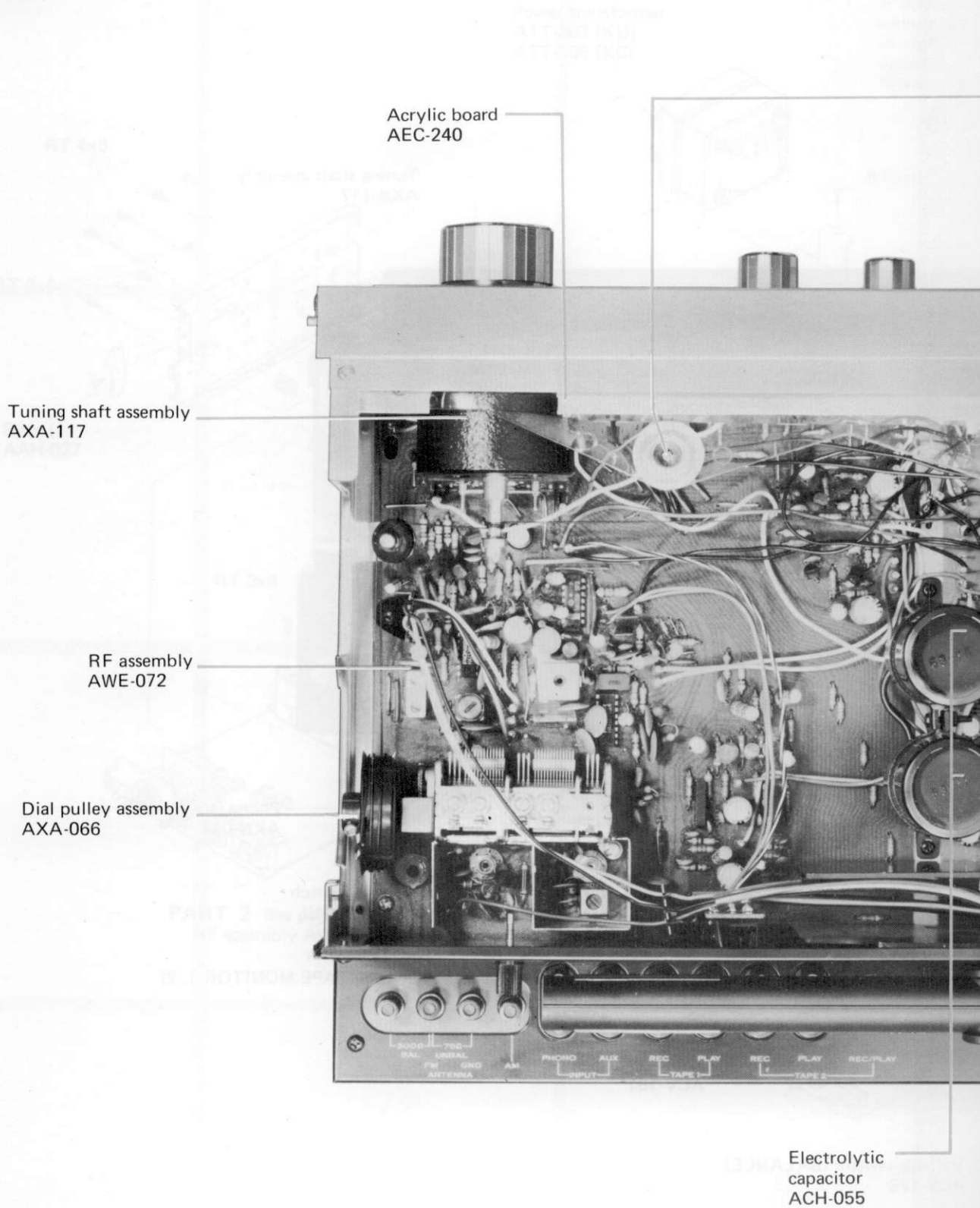

Acrylic board
AEC-240

Tuning shaft assembly
AXA-117

RF assembly
AWE-072

Dial pulley assembly
AXA-066

Electrolytic
capacitor
ACH-055

A
A

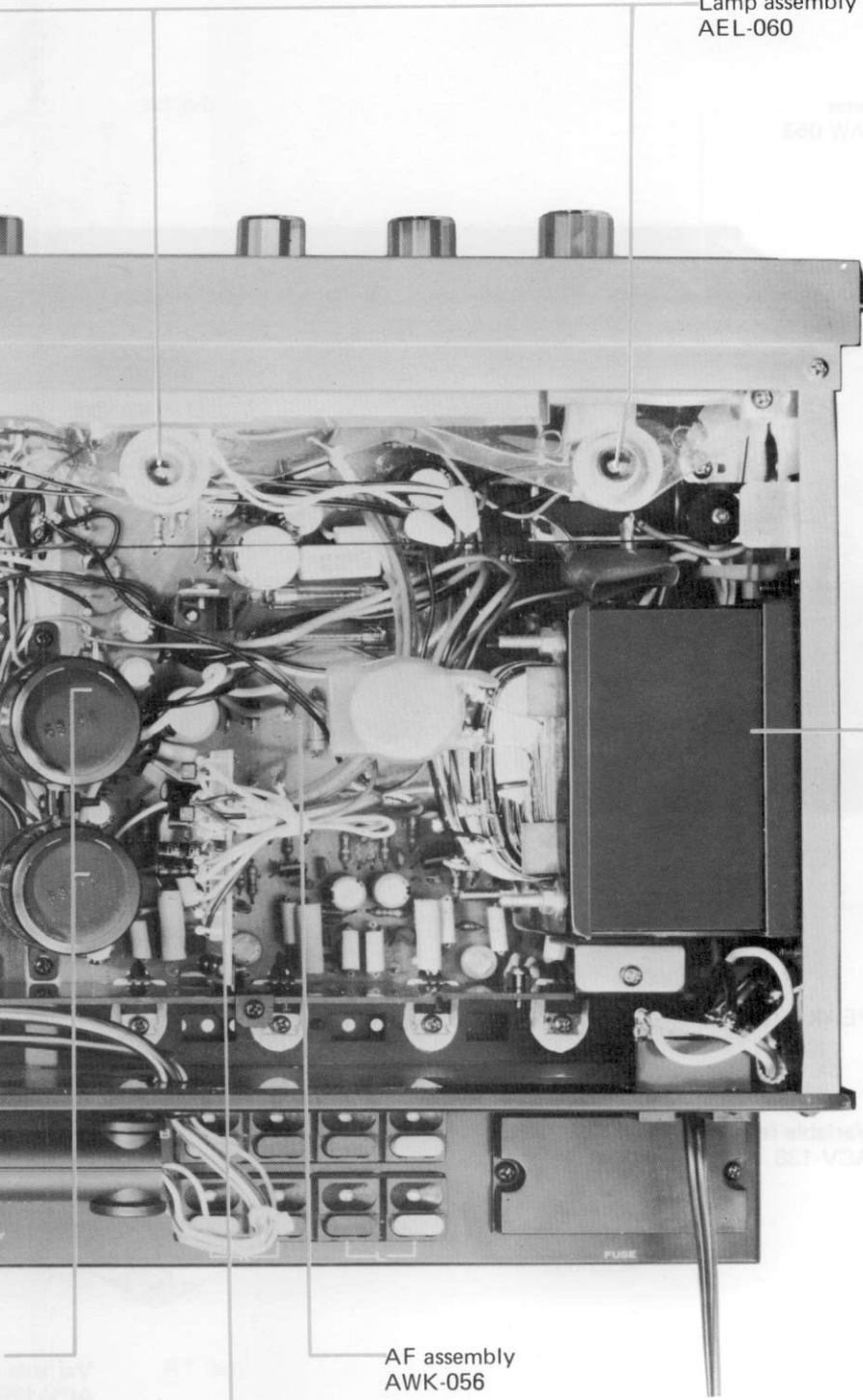

Lamp assembly (PL1,2,3)
AEL-060

Power transformer (T1)
ATT-263

AF assembly
AWK-056

AF MUTING assembly
AWM-101

10.4 FRONT VIEW

Meter
AAW-053

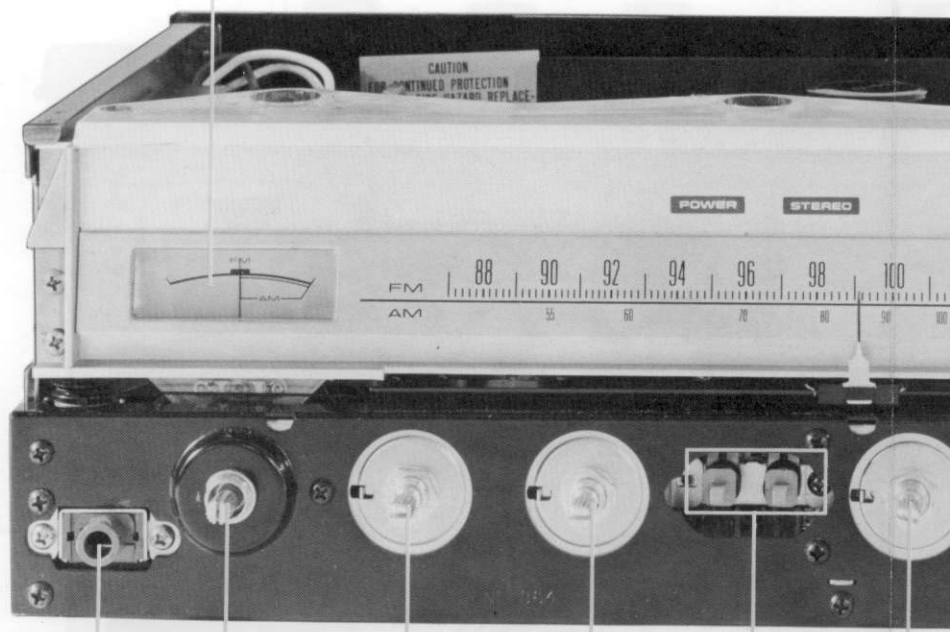

Phone jack (PHONES)
AKN-009

Selector switch (SPEAKER)
ASA-042

Variable resistor (BASS, TREBLE)
ACV-138

Push switch (FM MUTING, MODE)
ASG-092

Variable re
ACV-126

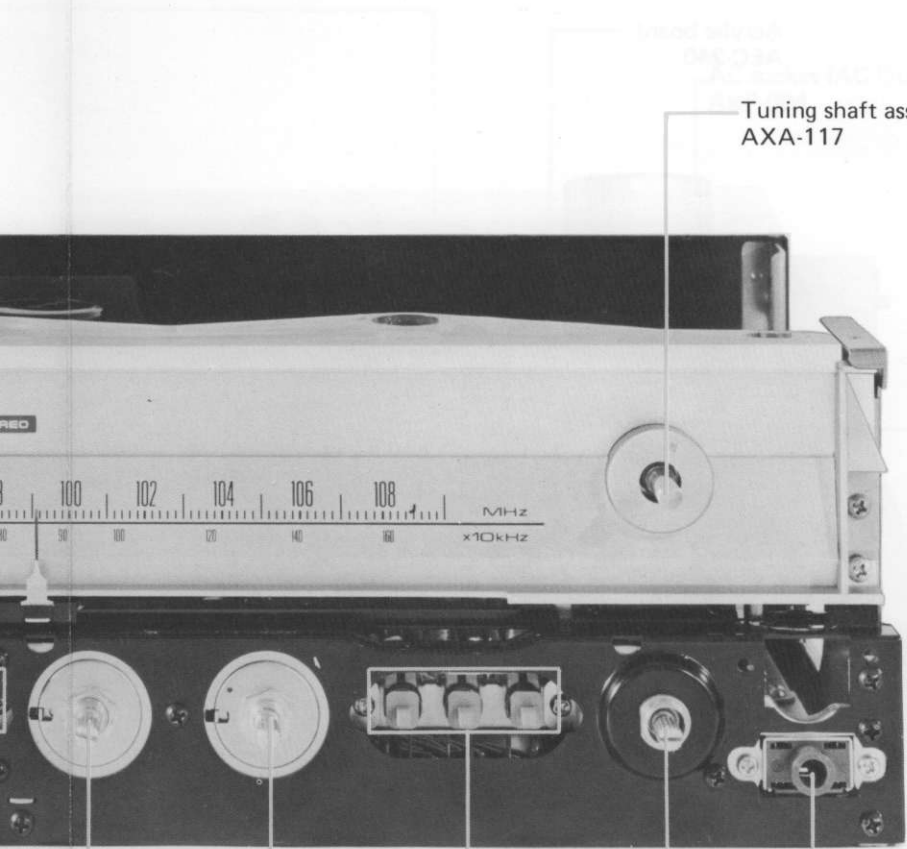

Tuning shaft assembly
AXA-117

Phone jack (MIC)
AKN-011

Selector switch
(FUNCTION)
ASD-048

Push switch (LOUDNESS, TAPE MONITOR 1, 2)
ASG-093

Variable resistor (VOLUME)
ACV-161

Variable resistor (BALANCE)
ACV-126

11. EXPLODED VIEWS

11.1 EXTERIOR

A

Lamp assembly (PL1, 2, 3)
AEL-060

Wire connector
AEC-308

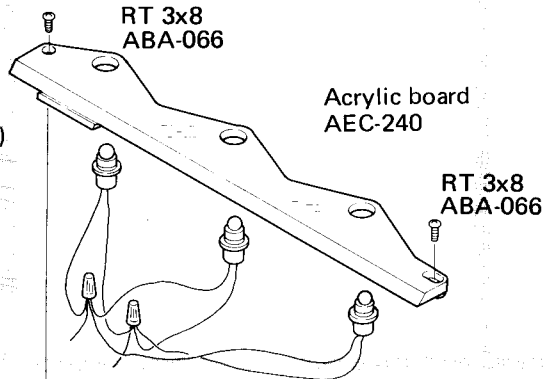

Acrylic board
AEC-240

RT 3x8
ABA-066

Screw
ABA-113

B

RT 3x6

Dial scale board
AAG-113

Meter
AAW-053

Lamp
AEL-062

RT 3x6

Lamp
AEL-061

Rubber bracket
AEB-080

Side board (L)
AMS-012

Plate (L)
AAH-027

capacitor
ACG-001

C

RT 3x6
BM 3x8

Knob (FM MUTING, MONO, LOUDNESS, TAPE MONITOR)
AAD-110

Dial pointer
AAF-046

Nylon sheet
AEC-191

Washer
B22-017

Nut
B71-005

BM 3x8

Spring
ABH-025

Spacer
AEC-301

D

Knob (BASS, TREBLE, BALANCE)
AAB-099

Knob (TUNING)
AAA-036

Knob (SPEAKER, VOLUME, FUNCTION)
AAB-100

Washer
B22-017

Nut
B71-005

Front panel assembly
ANB-417

1

2

3

4

5

6

NOTE:

Parts indicated in green type cannot be supplied.

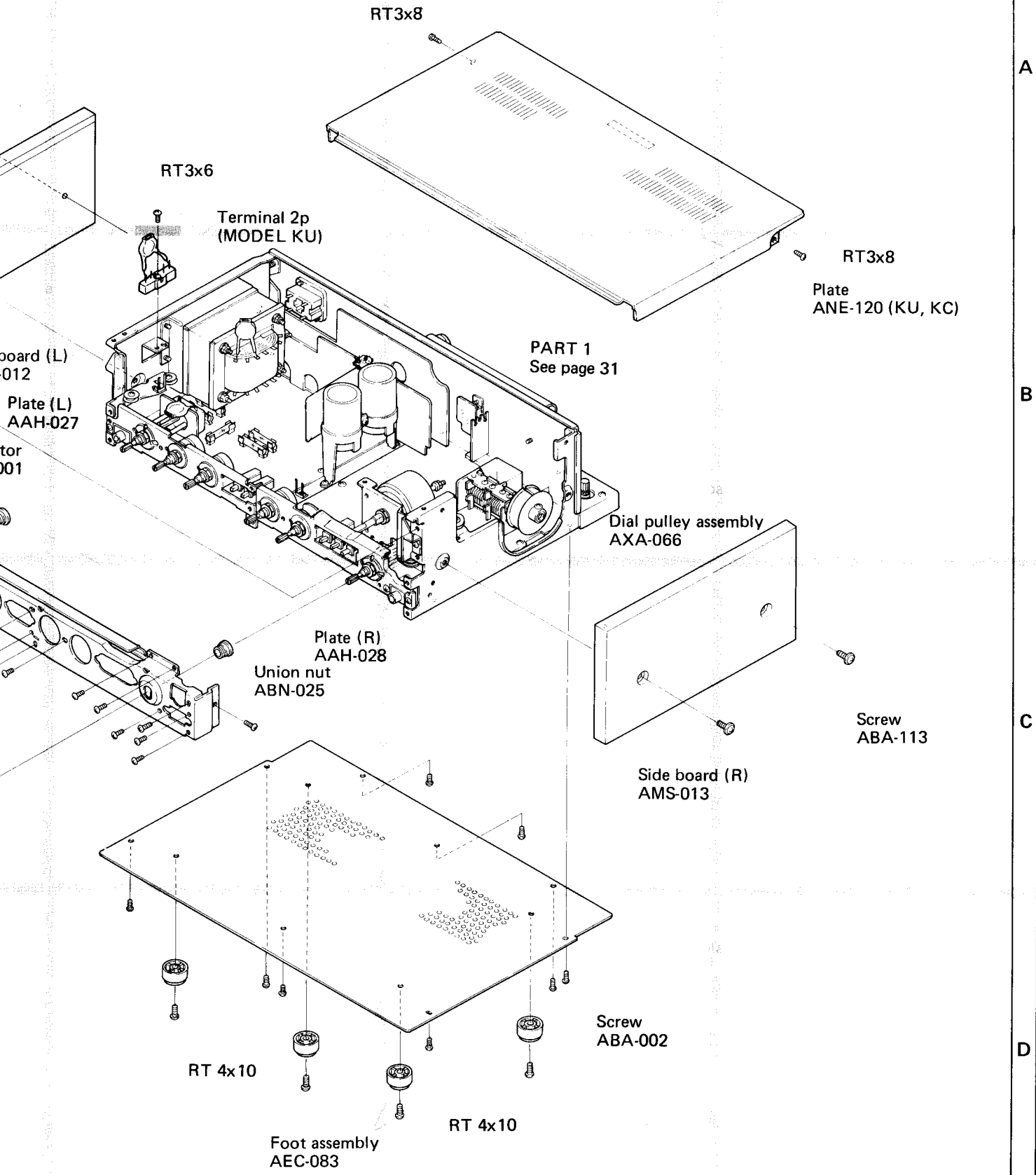

4

5

6

A
B
C
D

11.2 PART 1

NOTE:
If set is a K
screwdriver.
in damage.
opposite screw
this screw.

A

B

C

D

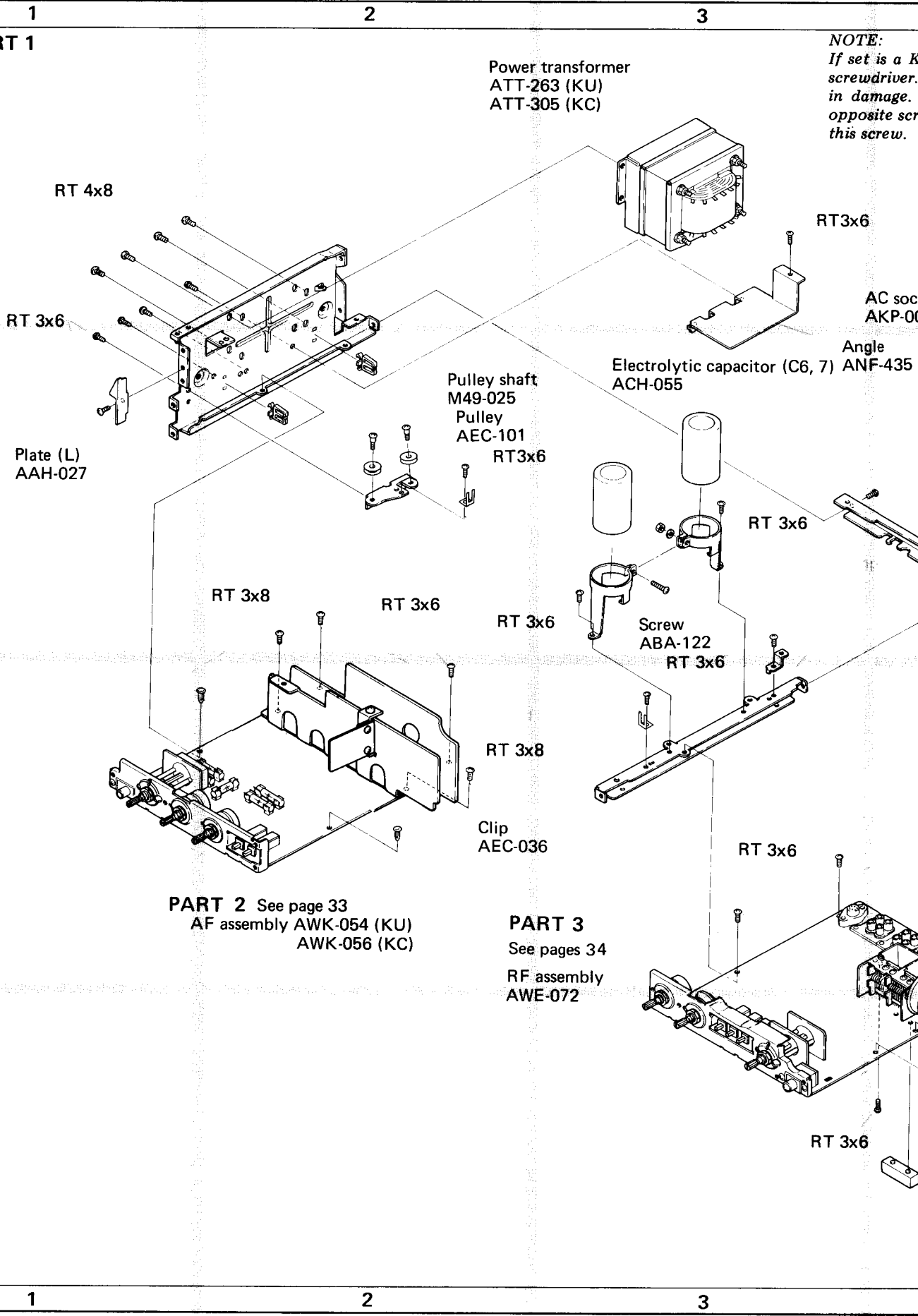

Power transformer
ATT-263 (KU)
ATT-305 (KC)

RT 4x8

RT 3x6

Plate (L)
AAH-027

Pulley shaft
M49-025
Pulley
AEC-101
RT3x6

RT 3x8

RT 3x6

RT 3x8

Clip
AEC-036

PART 2 See page 33
AF assembly AWK-054 (KU)
AWK-056 (KC)

PART 3
See pages 34
RF assembly
AWE-072

Electrolytic capacitor (C6, 7) ANF-435
ACH-055

RT3x6

AC sock
AKP-00

Angle

Screw
ABA-122
RT 3x6

RT 3x6

RT 3x6

RT 3x6

1

2

3

4

5

6

NOTE:
 If set is a KC model, this screw cannot be removed with a screwdriver. Forcibly attempting to remove it will result in damage. To remove the fuse cover, first take out the opposite screw, then turn the entire fuse cover to unfasten this screw.

NOTE:
 Parts indicated in green type cannot be supplied.

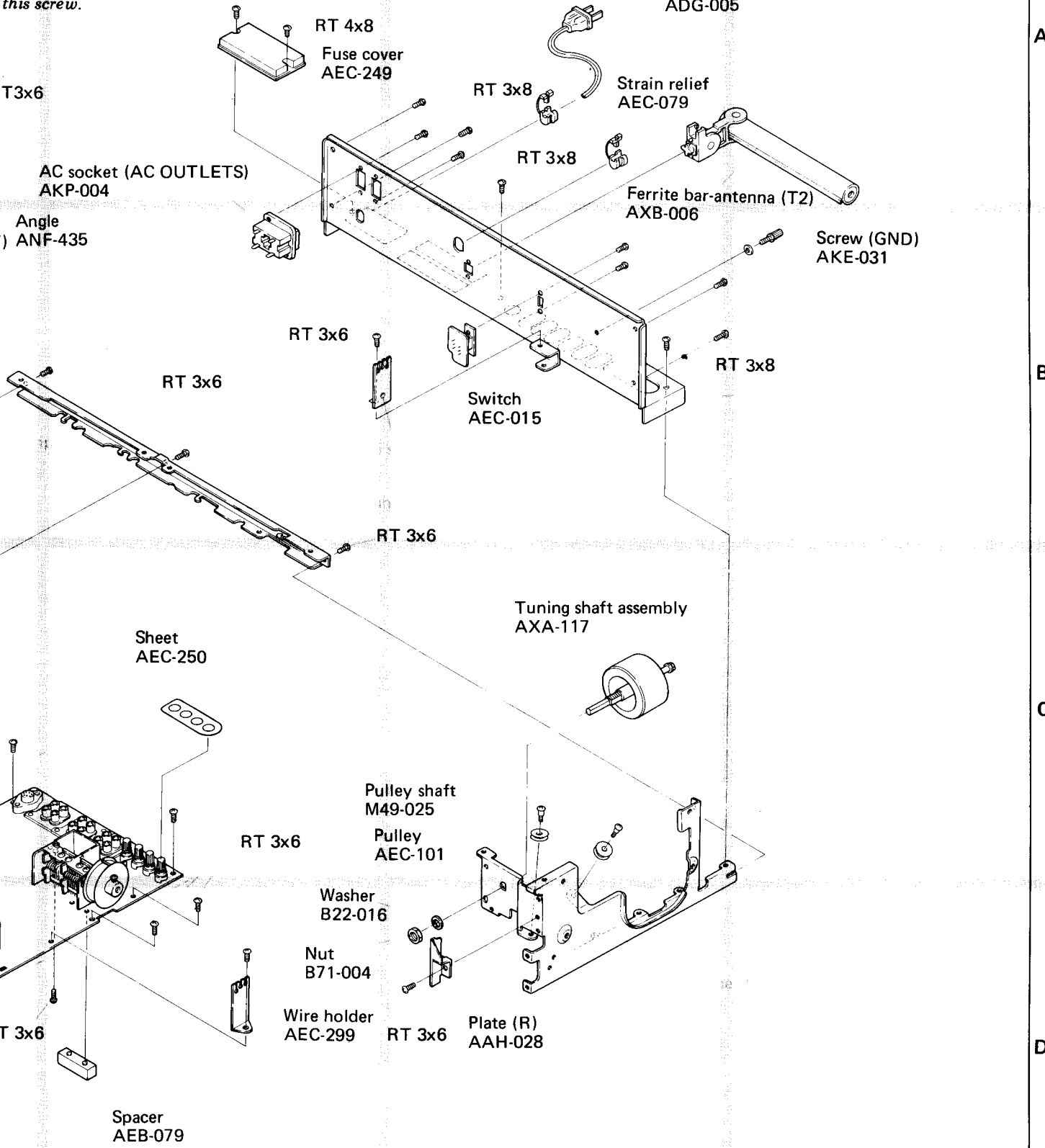

4

5

6

A
 B
 C
 D

11.3 PART 2 AF ASSEMBLY AWK-056

NOTE:

Parts indicated in green type cannot be supplied.

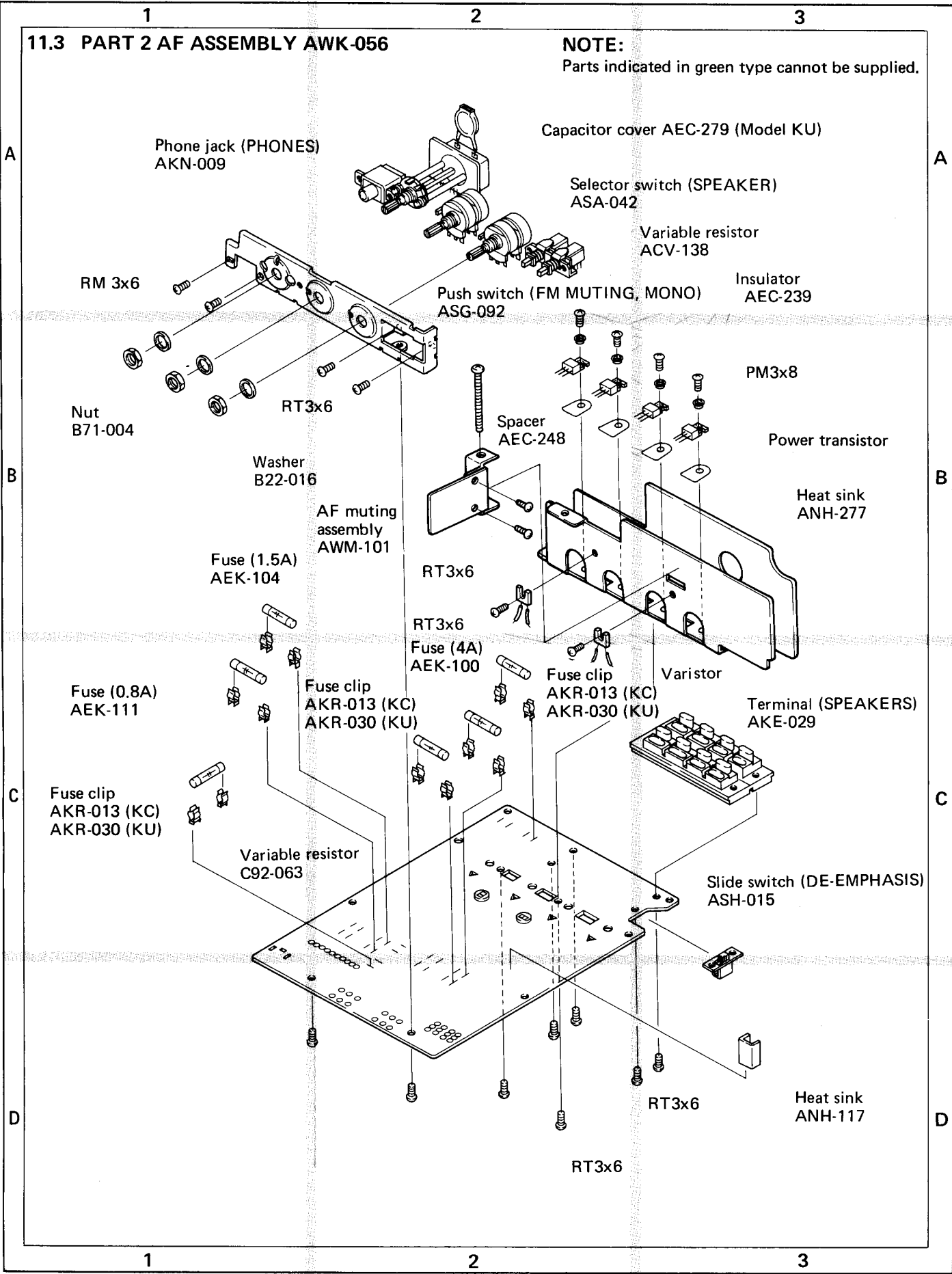

11.4 PART 3 RF ASSEMBLY AWE-072

NOTE:

Parts indicated in green type cannot be supplied.

Variable resistor
ACV-126

Variable resistor
ACV-161

Push switch
ASG-093

Selector switch (FUNCTION)
ASD-048

Phone jack (MIC)
AKN-011

Nut
B71-004

PM 3x6

5P connector socket (REC/PLAY)
AKP-011

Washer
B22-016

Terminal 4P
AKB-027

Variable
capacitor
ACK-012

Terminal (ANTENNA)
AKE-028

RT3x6

RT3x6

Dial pulley assembly
AXA-066

A

A

B

B

C

C

D















D











1 2 3

1 2 3

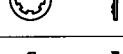
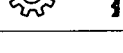
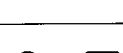
NOMENCLATURE OF SCREWS, WASHERS AND NUTS

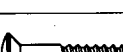
The following symbols stand for screws, washers and nuts as shown in exploded view.

Symbol	Description	Shape
RT	Brazier head tapping screw	
PT	Pan head tapping screw	
BT	Binding head tapping screw	
CT	Countersunk head tapping screw	
TT	Truss head tapping screw	
OCT	Oval countersunk head tapping screw	
PM	Pan head machine screw	
CM	Countersunk head machine screw	
OCM	Oval countersunk head machine screw	
TM	Truss head machine screw	
BM	Binding head machine screw	
PSA	Pan head screw with spring lock washer	
PSB	Pan head screw with spring lock washer and flat washer	
PSF	Pan head screw with flat washer	

Symbol	Description	Shape
EW	E type washer	
FW	Flat washer	
SW	Spring lock washer	
N	Nut	
WN	Washer faced nut	
ITW	Internal toothed lock washer	
OTW	Outernal toothed lock washer	
SC	Slotted set screw (Cone point)	
SF	Slotted set screw (Flat point)	
HS	Hexagon socket headless set screw	
OCW	Oval countersunk head wood screw	
CW	Countersunk head wood screw	
RW	Round head wood screw	

EXAMPLE

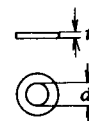
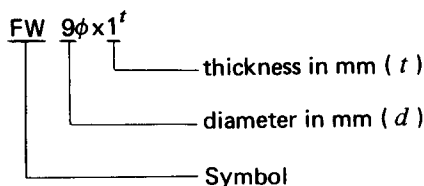
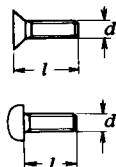
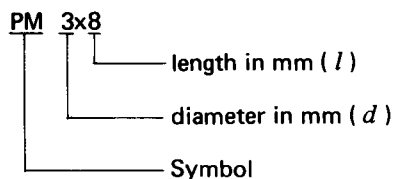

12. SCHEMATIC DIAGRAMS, P.C. BOARD PATTERNS AND PARTS LISTS.

12.1 MISCELLANEOUS PARTS LIST

NOTES:

- Capacitors: in μF unless otherwise noted p:pF
- Resistors: in Ω , $\frac{1}{4}W$ unless otherwise noted k:k Ω , M:M Ω

TRANSFORMERS AND COILS

Symbol	Description	Part No.
T1	Power transformer	ATT-263 (KU) ATT-305 (KC)
T2	Bar-antenna assembly	AXB-006

CAPACITORS

Symbol	Description	Part No.
C1	Ceramic 0.01 250V	ACG-001
C2	Ceramic 0.01 125V	ACG-003
C3	Ceramic 0.01 50V	CKDYF 103Z 50
C4	Ceramic 0.01 50V	CKDYF 103Z 50
C5	Ceramic 0.01 50V	CKDYF 103Z 50
C6	Electrolytic 6,800 35V	ACH-055
C7	Electrolytic 6,800 35V	ACH-055
C8	Ceramic 0.01 50V	CKDYF 103Z 50

LAMPS AND FUSES

Symbol	Description	Part No.
PL1	Lamp assembly (8V, 300mA)	AEL-060
PL2	Lamp assembly (8V, 300mA)	AEL-060
PL3	Lamp assembly (8V, 300mA)	AEL-060
PL4	Power indicator (6V, 50mA)	AEL-062
PL5	Stereo indicator (6V, 50mA)	AEL-061
FU1	Fuse (4A)	AEK-100
FU2	Fuse (4A)	AEK-100
FU3	Fuse (0.8A)	AEK-111
FU4	Fuse (0.8A)	AEK-111
FU5	Fuse (1.5A)	AEK-104
FU6	Fuse (4A)	AEK-100

RESISTOR

Symbol	Description	Part No.
R1	Carbon film 2.2M $\frac{1}{4}W$	RD $\frac{1}{2}$ PS 225J

External Appearance of Transistors and ICs

2SA816
2SB596
2SD313
2SD526

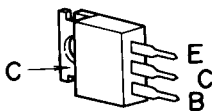

HA1137
HA1138

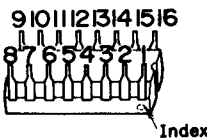

2SA697
2SA725
2SC1211
2SC1312



2SA798

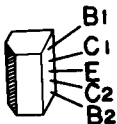

TA7136P1

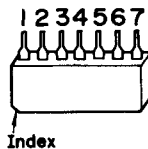

HA1156W-P

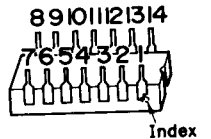

2SC945
2SC945A
2SC1438

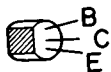

2SC461
2SC535

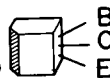

2SK55

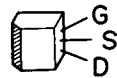

12.2 SCHEMATIC DIAGRAM

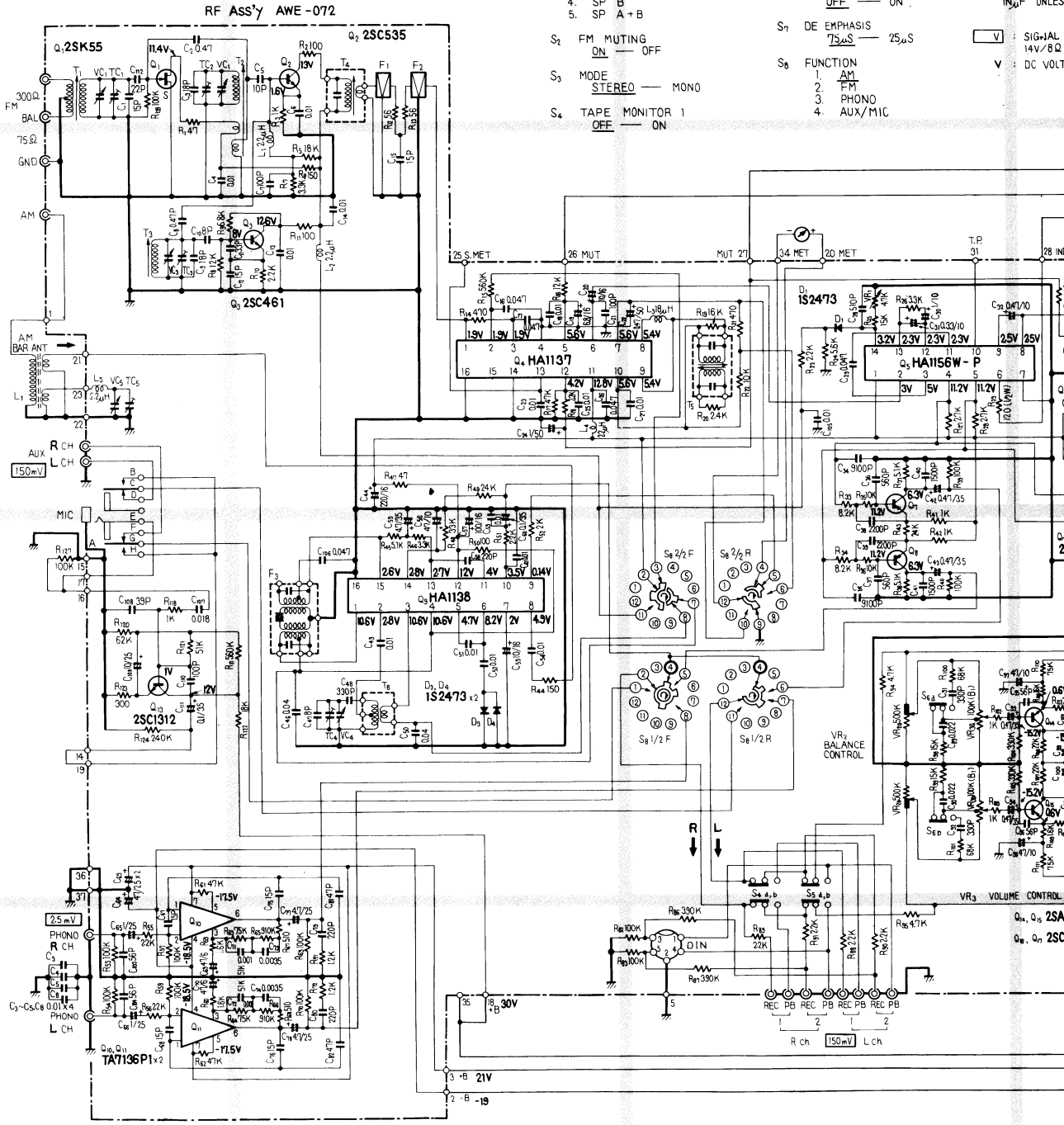

SWITCHES:

- S₁ SPEAKERS
1. POWER OFF
- 2. SP A
- 3. SP OFF
- 4. SP B
- 5. SP A+B
- S₂ FM MUTING
ON — OFF
- S₃ MODE
STEREO — MONO
- S₄ TAPE MONITOR 1
OFF — ON

- S₅ TAPE MONITOR 2
OFF — ON
- S₆ LOUDNESS
OFF — ON
- S₇ DE EMPHASIS
75μS — 25μS
- S₈ FUNCTION
1. AM
2. FM
3. PHONO
4. AUX/MIC

RESISTORS:
IN OHM, 1/4
OTHERWISE

CAPACITORS:
IN μF UNLESS
OTHERWISE

⊞ V — SIGNAL
⊞ V — DC VOLT

A

B

C

D

1

2

3

Circuit Diagrams of ICs

HA1137 (FM IF IC)

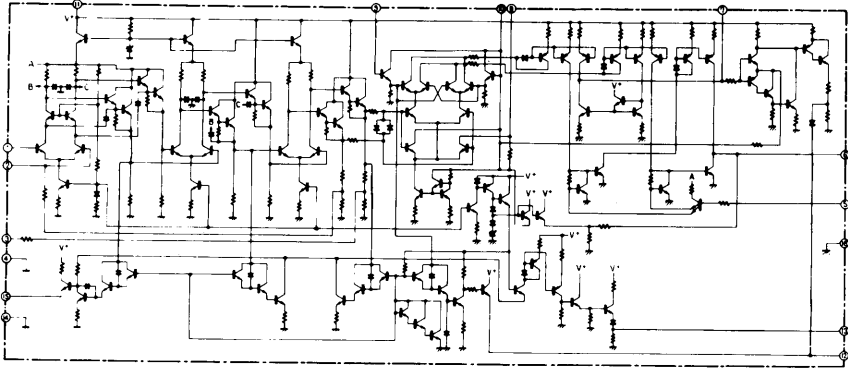

HA1156 (FM MPX IC)

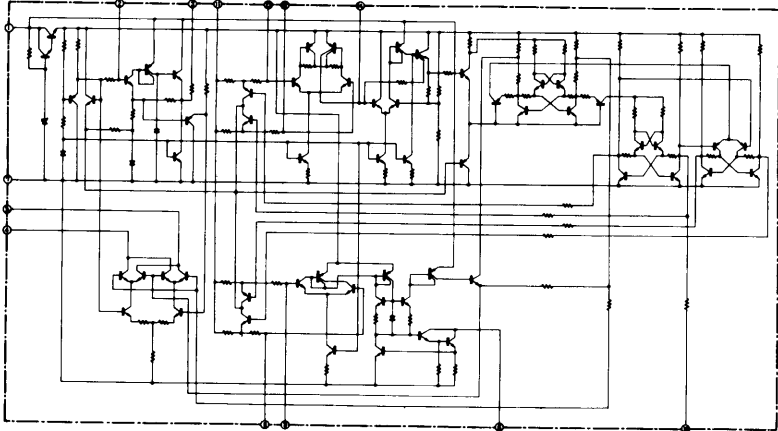

HA1138 (AM IC)

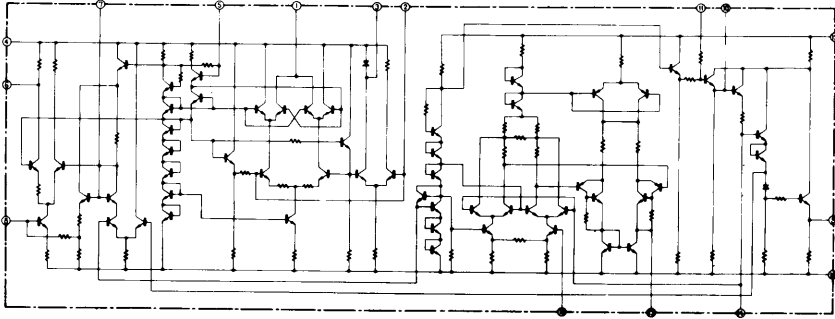

TA7136P1

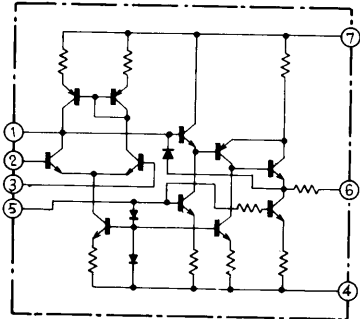

12.3 RF ASSEMBLY (AWE-072-0)

SEMICONDUCTORS

Symbol	Description	Part No.
Q1	Transistor	2SK55-D
Q2	Transistor	2SC535-A or B
Q3	Transistor	2SC461-B
Q4	IC	HA1137
Q5	IC	HA1156W-P
Q6	Transistor	2SC956A-Q or R
Q7	Transistor	2SA725-F or G
Q8	Transistor	2SA725-F or G
Q9	IC	HA1138
Q10	IC	TA7136P1
Q11	IC	TA7136P1
Q13	Transistor	2SC1312-F or G
Q14	Transistor	2SA725-F or G
Q15	Transistor	2SA725-F or G
Q16	Transistor	2SC1312-F or G
Q17	Transistor	2SC1312-F or G
D1	Diode	1S2473
D2	Diode	1S2473
D3	Diode	1S2473
D4	Diode	1S2473

OTHERS

Symbol	Description	Part No.
T1	FM antenna coil	ATC-030
T2	FM RF coil	ATC-024
T3	FM OSC coil	ATC-025
T4	FM IFT	ATE-026
T5	FM IFT	T73-035
T6	AM OSC coil	ATB-013
F1	FM ceramic filter	ATF-013
F2	FM ceramic filter	ATF-013
F3	AM ceramic filter	ATF-027
L1	RF choke coil	T24-028
L2	RF choke coil	T24-028
L3	RF choke coil	ATH-007
L4	RF choke coil	T24-028
L5	RF choke coil	T24-028
VR1	Semi-fixed resistor	C92-051
VR2	Variable resistor	ACV-126
VR3	Variable resistor	ACV-161
S1	Rotary switch	ASD-048
S2	Push switch	ASG-093
TC3	Tuning capacitor	ACK-012
	Ceramic trimmer	ACM-006

RESISTORS

Symbol	Description	Part No.
R1	Carbon film 47	RD $\frac{1}{2}$ PS 470J
R2	Carbon film 100	RD $\frac{1}{2}$ PS 101J
R3	Carbon film 1k	RD $\frac{1}{2}$ VS 102J
R5	Carbon film 18k	RD $\frac{1}{2}$ VS 183J
R6	Carbon film 150	RD $\frac{1}{2}$ VS 151J
R7	Carbon film 3.3k	RD $\frac{1}{2}$ VS 332J
R8	Carbon film 12k	RD $\frac{1}{2}$ VS 123J
R9	Carbon film 6.8k	RD $\frac{1}{2}$ VS 682J
R10	Carbon film 2.2k	RD $\frac{1}{2}$ VS 222J
R11	Carbon film 100	RD $\frac{1}{2}$ VS 101J
R12	Carbon film 56	RD $\frac{1}{2}$ VS 560J
R13	Carbon film 56	RD $\frac{1}{2}$ VS 560J
R14	Carbon film 470	RD $\frac{1}{2}$ PS 471J
R15	Carbon film 560k	RD $\frac{1}{2}$ VS 564J
R16	Carbon film 12k	RD $\frac{1}{2}$ PS 123J
R17	Carbon film 47k	RD $\frac{1}{2}$ VS 473J
R18	Carbon film 2.2k	RD $\frac{1}{2}$ PS 222J
R19	Carbon film 16k	RD $\frac{1}{2}$ VS 163J
R20	Carbon film 2.4k	RD $\frac{1}{2}$ PS 242J
R21	Carbon film 470	RD $\frac{1}{2}$ PS 471J
R22	Carbon film 10k	RD $\frac{1}{2}$ PS 103J
R23	Carbon film 2.2k	RD $\frac{1}{2}$ PS 222J
R24	Carbon film 5.6k	RD $\frac{1}{2}$ VS 562J
R25	Carbon film 15k	RD $\frac{1}{2}$ VS 153J
R26	Carbon film 3.3k	RD $\frac{1}{2}$ VS 332J
R27	Carbon film 2.7k	RD $\frac{1}{2}$ PS 272J
R28	Carbon film 2.7k	RD $\frac{1}{2}$ PS 272J
R29	Carbon film 120	RD $\frac{1}{2}$ PS 121J
R30	Carbon film 100k	RD $\frac{1}{2}$ PS 104J
R31	Carbon film 3.3k	RD $\frac{1}{2}$ VS 332J
R32	Carbon film 8.2k	RD $\frac{1}{2}$ PS 822J
R33	Carbon film 8.2k	RD $\frac{1}{2}$ PS 822J
R34	Carbon film 8.2k	RD $\frac{1}{2}$ PS 822J
R35	Carbon film 10k	RD $\frac{1}{2}$ PS 103J
R36	Carbon film 10k	RD $\frac{1}{2}$ PS 103J
R37	Carbon film 5.1k	RD $\frac{1}{2}$ PS 512J
R38	Carbon film 5.1k	RD $\frac{1}{2}$ PS 512J
R39	Carbon film 100k	RD $\frac{1}{2}$ PS 104J
R40	Carbon film 100k	RD $\frac{1}{2}$ PS 104J
R41	Carbon film 1k	RD $\frac{1}{2}$ PS 102J
R42	Carbon film 1k	RD $\frac{1}{2}$ PS 102J
R43	Carbon film 24k	RD $\frac{1}{2}$ PS 243J
R44	Carbon film 150	RD $\frac{1}{2}$ PS 151J
R45	Carbon film 5.1k	RD $\frac{1}{2}$ PS 512J
R46	Carbon film 3.3k	RD $\frac{1}{2}$ PS 332J
R47	Carbon film 47	RD $\frac{1}{2}$ VS 470J
R48	Carbon film 33k	RD $\frac{1}{2}$ VS 333J
R49	Carbon film 24k	RD $\frac{1}{2}$ PS 243J
R50	Carbon film 100	RD $\frac{1}{2}$ PS 101J
R51	Carbon film 2.2k	RD $\frac{1}{2}$ PS 222J

Symbol	Description	Part No.
R52	Carbon film 2k	RD%PS 202J
R53	Carbon film 100k	RD%PS 104J
R54	Carbon film 100k	RD%PS 104J
R55	Carbon film 2.2k	RD%PS 222J
R56	Carbon film 2.2k	RD%PS 222J
R57	Carbon film 100k	RD%PS 104J
R58	Carbon film 100k	RD%PS 104J
R59	Carbon film 1.6k	RD%PS 162J
R60	Carbon film 1.6k	RD%PS 162J
R61	Carbon film 47k	RD%PS 473J
R62	Carbon film 47k	RD%PS 473J
R63	Carbon film 75k	RD%PS 753J
R64	Carbon film 75k	RD%PS 753J
R65	Carbon film 910k	RD%PS 914J
R66	Carbon film 910k	RD%PS 914J
R67	Carbon film 510	RD%PS 511J
R68	Carbon film 510	RD%PS 511J
R69	Carbon film 100k	RD%PS 104J
R70	Carbon film 100k	RD%PS 104J
R71	Carbon film 1.2k	RD%PS 122J
R72	Carbon film 1.2k	RD%PS 122J
R82	Carbon film 100k	RD%PS 104J
R83	Carbon film 100k	RD%PS 104J
R86	Carbon film 390k	RD%PS 394J
R87	Carbon film 390k	RD%PS 394J
R88	Carbon film 2.2k	RD%PM 222J
R89	Carbon film 2.2k	RD%PM 222J
R90	Carbon film 2.2k	RD%PM 222J
R91	Carbon film 2.2k	RD%PM 222J
R94	Carbon film 4.7k	RD%PS 472J
R95	Carbon film 4.7k	RD%PS 472J
R98	Carbon film 15k	RD%PS 153J
R99	Carbon film 15k	RD%PS 153J
R100	Carbon film 68k	RD%PS 683J
R101	Carbon film 68k	RD%PS 683J
R102	Carbon film 1.1k	RD%PS 112J
R103	Carbon film 1.1k	RD%PS 112J
R104	Carbon film 330k	RD%PS 334J
R105	Carbon film 330k	RD%PS 334J
R106	Carbon film 22k	RD%PS 223J
R107	Carbon film 22k	RD%PS 223J
R108	Carbon film 1.6k	RD%PS 162J
R109	Carbon film 1.6k	RD%PS 162J
R110	Carbon film 75k	RD%PS 753J
R111	Carbon film 75k	RD%PS 753J
R112	Carbon film 22k	RD%PS 223J
R113	Carbon film 22k	RD%PS 223J
R114	Carbon film 56	RD%PS 560J
R115	Carbon film 56	RD%PS 560J
R116	Carbon film 10k	RD%PS 103J

Symbol	Description	Part No.
R117	Carbon film 10k	RD%PS 103J
R118	Carbon film 1k	RD%PM 102J
R119	Carbon film 560k	RD%PS 564JNL
R120	Carbon film 62k	RD%PS 623JNL
R121	Carbon film 51k	RD%PS 513JNL
R122	Carbon film 18k	RD%PM 183J
R123	Carbon film 300	RD%PM 301J
R124	Carbon film 240k	RD%PM 244J
R125	Carbon film 51k	RD%VS 513J
R126	Carbon film 51k	RD%VS 513J
R127	Carbon film 100k	RD%PS 104J
R128	Carbon film 100k	RD%PS 104J

CAPACITORS

Symbol	Description	Part No.
C1	Ceramic 15p 50V	CCDSH 150K 50
C2	Ceramic 0.47p 500V	CGB R47K 500
C3	Ceramic 18p 50V	CCDTH 180K 50
C4	Ceramic 0.01 50V	CKDYF 103Z 50
C5	Ceramic 10p 50V	CCDSL 100K 50
C6	Ceramic 0.01 50V	CKDYF 103Z 50
C7	Ceramic 100p 50V	CCDSL 101K 50
C8	Ceramic 0.47p 500V	CGB R47K 500
C9	Ceramic 18p 50V	CCDPH 180K 50
C10	Ceramic 8p 50V	CCDSH 080F 50
C11	Ceramic 33p 50V	CCDCH 330K 50
C12	Ceramic 15p 50V	CCDCH 150K 50
C13	Ceramic 0.01 50V	CKDYB 103K 50
C14	Ceramic 0.01 50V	CKDYF 103Z 50
C15	Ceramic 15p 50V	CCDSL 150K 50
C16	Ceramic 0.047 50V	CKDYF 473Z 50
C17	Ceramic 0.047 50V	CKDYF 473Z 50
C18	Ceramic 0.01 50V	CKDYF 103Z 50
C19	Electrolytic 6.8 16V	CSZA 6R8M 16
C20	Electrolytic 10 16V	CEA 100P 16
C21	Ceramic 100p 50V	CCDSL 101K 50
C22	Electrolytic 0.47 50V	CEA R47P 50
C23	Ceramic 0.01 50V	CKDYF 103Z 50
C24	Electrolytic 1 50V	CEA 010P 50
C25	Ceramic 0.01 50V	CDKYF 103Z 50
C26	Ceramic 0.047 50V	CKDYF 473Z 50
C27	Ceramic 0.01 50V	CKDYF 103Z 50
C28	Polystyrene 510p 50V	CQSH 511J 50
C29	Mylar 0.047 50V	CQMA 473J 50
C30	Electrolytic 1 25V	CSSA 010M 25
C31	Electrolytic 0.33 10V	CSSA R33M 10
C32	Electrolytic 0.47 10V	CSSA R47M 10
C33	Electrolytic 10 16V	CEA 100P 16

Symbol	Description			Part No.
C34	Mylar	0.0091	50V	CQMA 912J 50
C35	Mylar	0.0091	50V	CQMA 912J 50
C36	Ceramic	560p	50V	CKDYB 561K 50
C37	Ceramic	560p	50V	CKDYB 561K 50
C38	Ceramic	0.0022	50V	CKDYB 222K 50
C39	Ceramic	0.0022	50V	CKDYB 222K 50
C40	Ceramic	0.0015	50V	CKDYB 152K 50
C41	Ceramic	0.0015	50V	CKDYB 152K 50
C42	Electrolytic	0.47	35V	CSZA R47M 35
C43	Electrolytic	0.47	35V	CSZA R47M 35
C44	Electrolytic	220	16V	CEA 221P 16
C45
C46	Ceramic	0.04	50V	CKDYF 403Z 50
C47	Ceramic	8p	50V	CCDXL 080F 50
C48	Styrol	330p	50V	CQSA 331J 50
C49	Ceramic	0.01	50V	CKDYB 103K 50
C50	Ceramic	0.04	50V	CKDYF 403Z 50
C51	Ceramic	0.01	50V	CKDYF 103Z 50
C52	Ceramic	0.01	50V	CKDYF 103Z 50
C53	Electrolytic	10	16V	CEA 100P 16
C54	Ceramic	0.01	50V	CKDYF 103Z 50
C55	Electrolytic	4.7	35V	CEA 4R7P 35
C56	Electrolytic	47	10V	CEA 470P 10
C57	Electrolytic	100	16V	CEA 101P 16
C58	Ceramic	220p	50V	CCDSL 221K 50
C59	Ceramic	0.01	50V	CKDYF 103Z 50
C60	Electrolytic	0.1	35V	CSZA 0R1M 35
C61	Ceramic	0.01	50V	CKDYF 103Z 50
C62
C63	Electrolytic	47	25V	CEA 470P 25
C64	Electrolytic	47	25V	CEA 470P 25
C65	Electrolytic	1	25V	CSSA 010M 25
C66	Electrolytic	1	25V	CSSA 010M 25
C67	Ceramic	15p	50V	CCDSL 150K 50
C68	Ceramic	15p	50V	CCDSL 150K 50
C69	Electrolytic	47	6V	CEA 470P 6
C70	Electrolytic	47	6V	CEA 470P 6
C71	Styrol	1000p	50V	CQSA 102G 50
C72	Styrol	1000p	50V	CQSA 102G 50
C73	Styrol	3500p	50V	CQSA 352G 50
C74	Styrol	3500p	50V	CQSA 352G 50
C75	Ceramic	15p	50V	CCDSL 150K 50
C76	Ceramic	15p	50V	CCDSL 150K 50
C77	Electrolytic	4.7	25V	CEANL 4R7P 25
C78	Electrolytic	4.7	25V	CEANL 4R7P 25
C79	Ceramic	220p	50V	CCDSL 221K 50
C80	Ceramic	220p	50V	CCDSL 221K 50

Symbol	Description			Part No.
C81	Ceramic	47p	50V	CCDSL 470K 50
C82	Ceramic	47p	50V	CCDSL 470K 50
C89	Mylar	0.022	50V	CQMA 223J 50
C90	Mylar	0.022	50V	CQMA 223J 50
C91	Ceramic	330p	50V	CDKYB 331K 50
C92	Ceramic	330p	50V	CKDYB 331K 50
C93	Electrolytic	0.47	35V	CSZA R47M 35
C94	Electrolytic	0.47	35V	CSZA R47M 35
C95	Ceramic	56p	50V	CCDSL 560K 50
C96	Ceramic	56p	50V	CCDSL 560K 50
C97	Electrolytic	47	10V	CEA 470P 10
C98	Electrolytic	47	10V	CEA 470P 10
C99	Electrolytic	470	6V	CEA 471P 6
C100	Electrolytic	470	6V	CEA 471P 6
C101	Ceramic	5p	50V	CCDSL 050D 50
C102	Ceramic	5p	50V	CCDSL 050D 50
C103	Ceramic	56p	50V	CCDSL 560K 50
C104	Ceramic	56p	50V	CCDSL 560K 50
C105	Ceramic	0.01	50V	CKDYF 103Z 50
C106	Ceramic	0.047	50V	CKDYF 473Z 50
C107	Mylar	0.018	50V	CQMA 183J 50
C108	Ceramic	39p	50V	CCDSL 390K 50
C109	Electrolytic	10	25V	CEA 100P 25
C110	Ceramic	100p	50V	CCDSL 101K 50
C111	Electrolytic	0.1	35V	CSZA 0R1M 35
C112	Ceramic	22p	50V	CCDSL 220K 50

RF Assembly (AWE-072-)

A

B

C

D

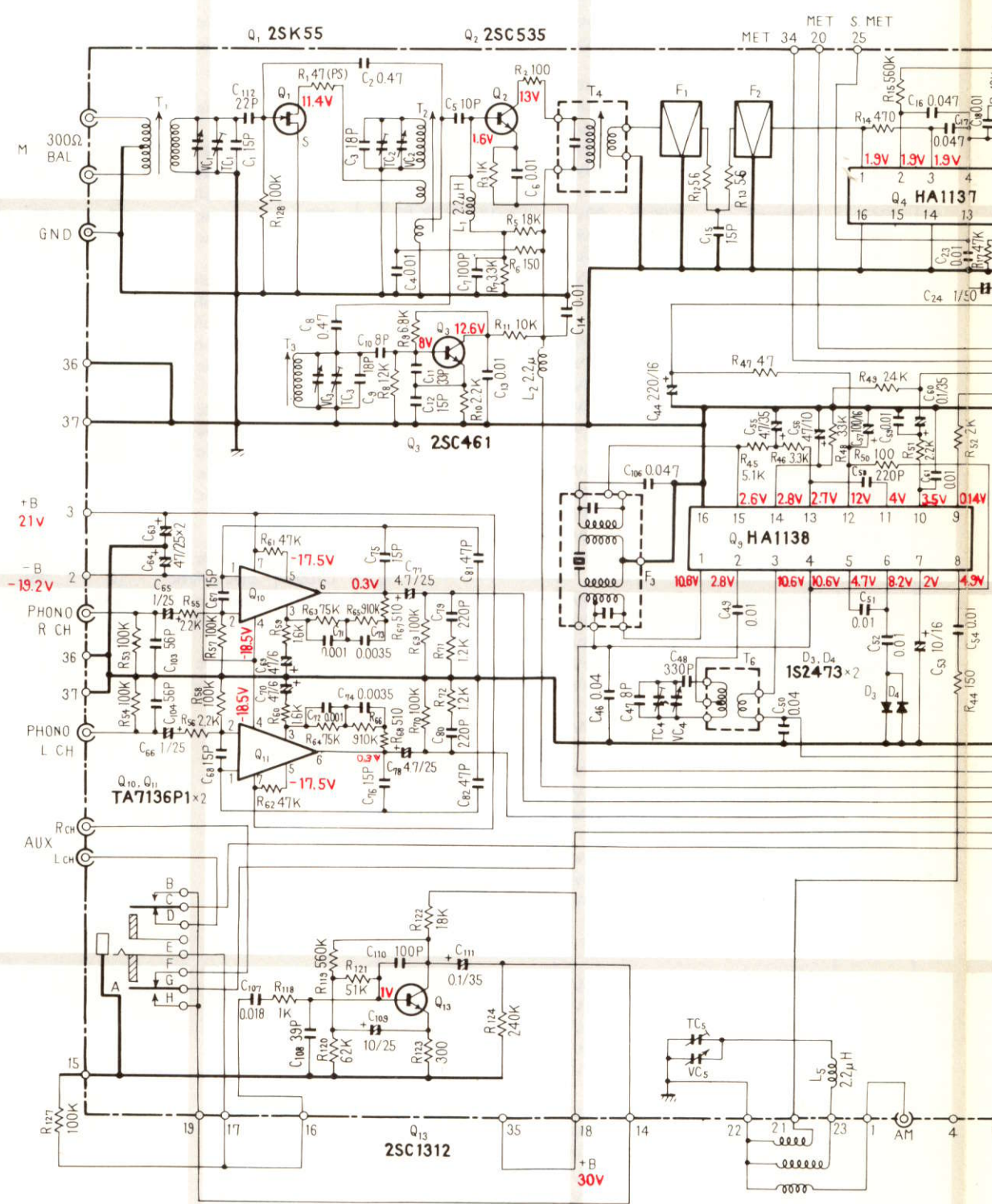

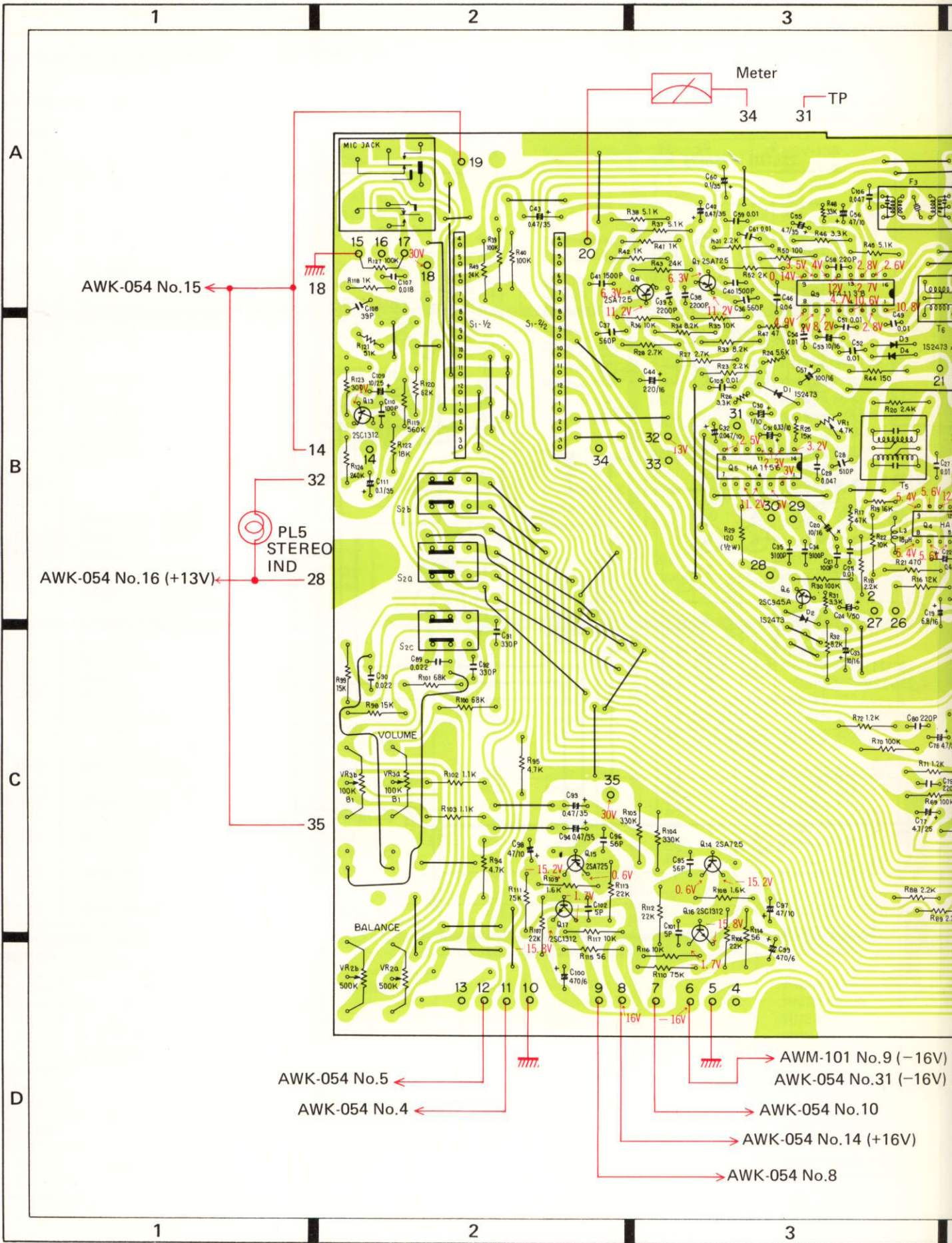

AWK-054 No. 15

AWK-054 No. 16 (+13V)

AWK-054 No. 5

AWK-054 No. 4

AWM-101 No. 9 (-16V)

AWK-054 No. 31 (-16V)

AWK-054 No. 10

AWK-054 No. 14 (+16V)

AWK-054 No. 8

Meter

TP

PL5
STEREO
IND

A

B

C

D

1

2

3

1

2

3

4

5

6

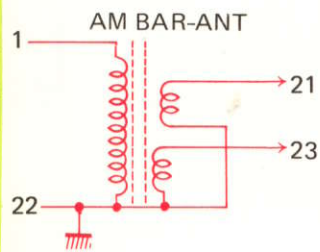
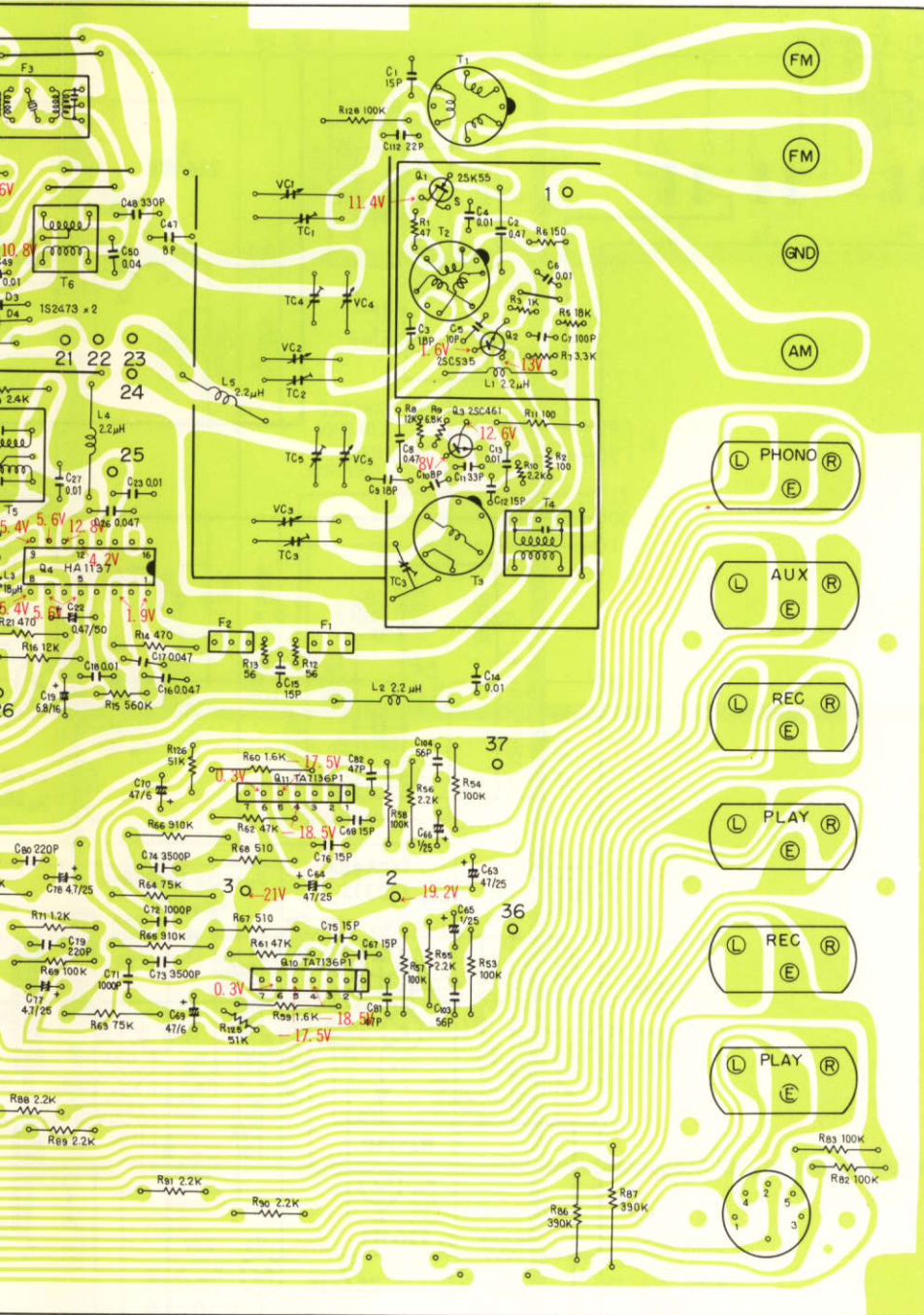

26 → AWK-054 No.6
 27 → AWK-054 No.7

2 → AWM-101 No.8 (-19V)
 AWK-054 No.32 (-19V)
 3 → AWK-054 No.13 (+21V)
 AWM-101 No.6 (+21V)

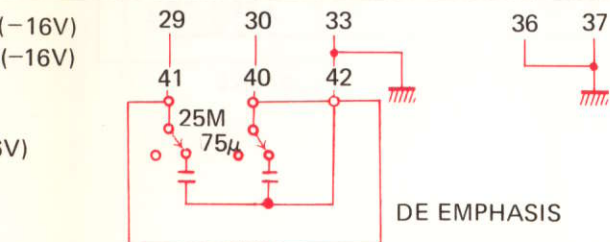

4

5

6

A

B

C

D

12.4 AF AMPLIFIER ASSEMBLY (AWK-056)

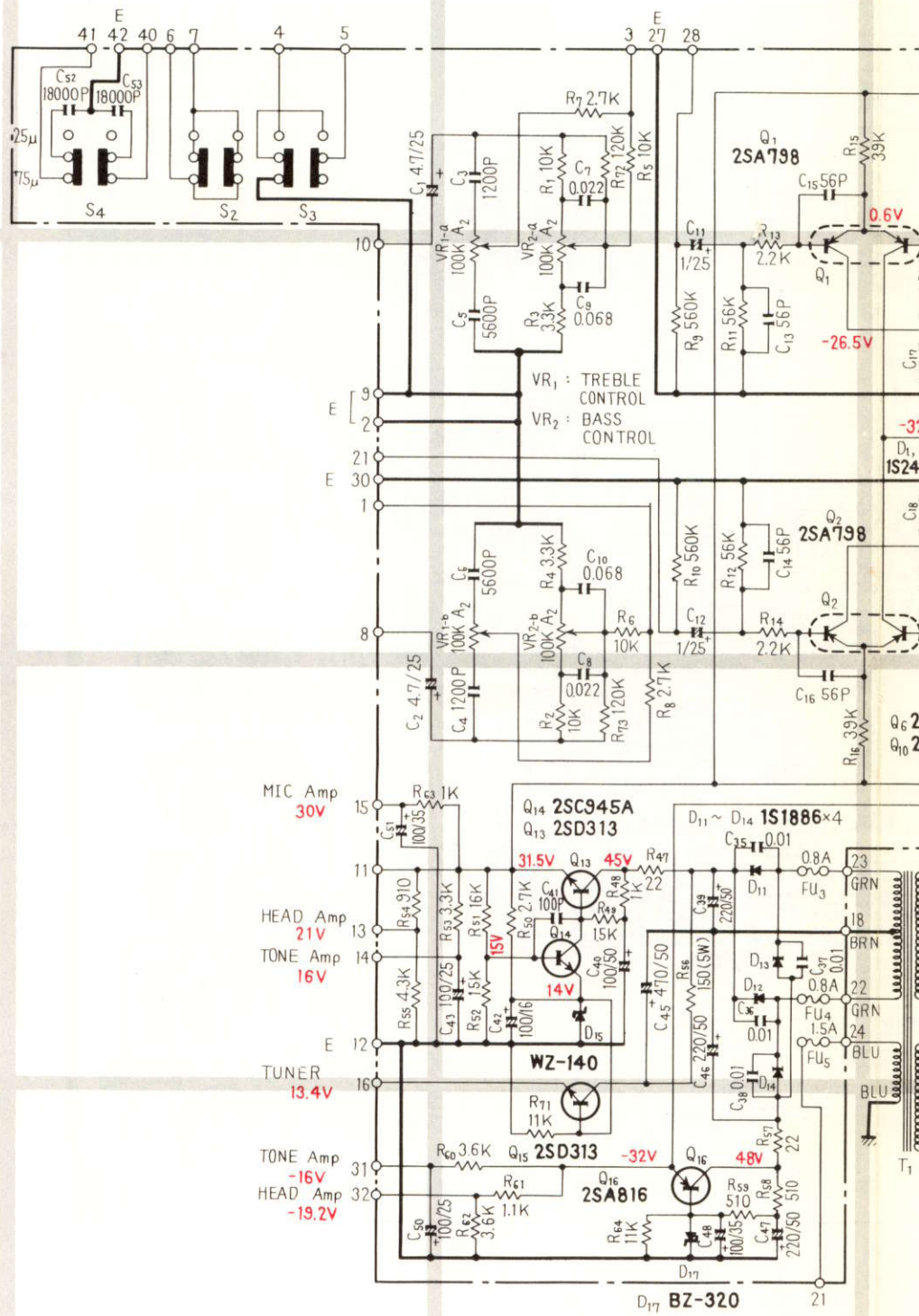

A
B
C
D

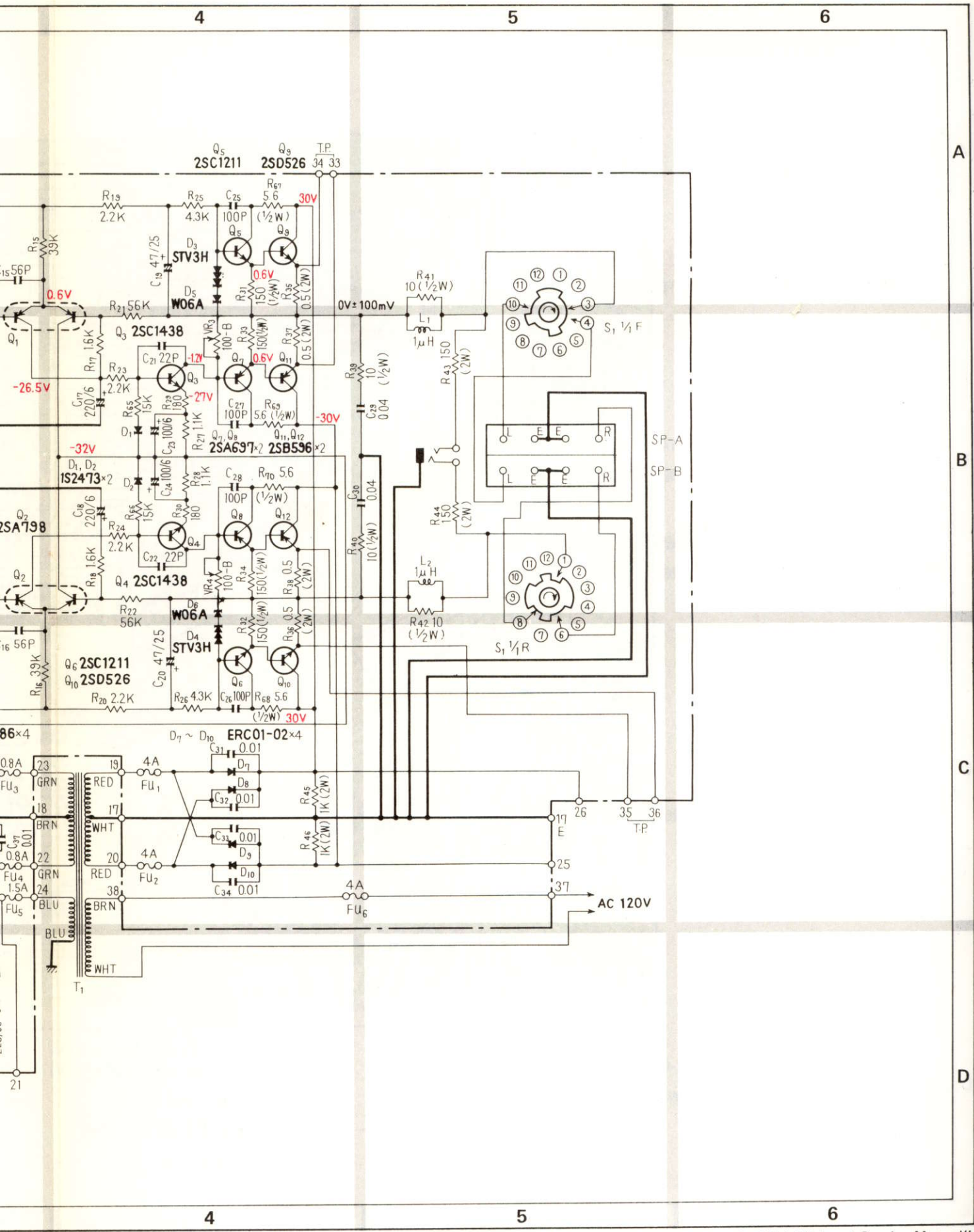

For AWK-054 service information refer to page 2 of "Additional Service Manual".

1

2

3

A

B

C

D

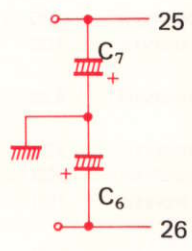
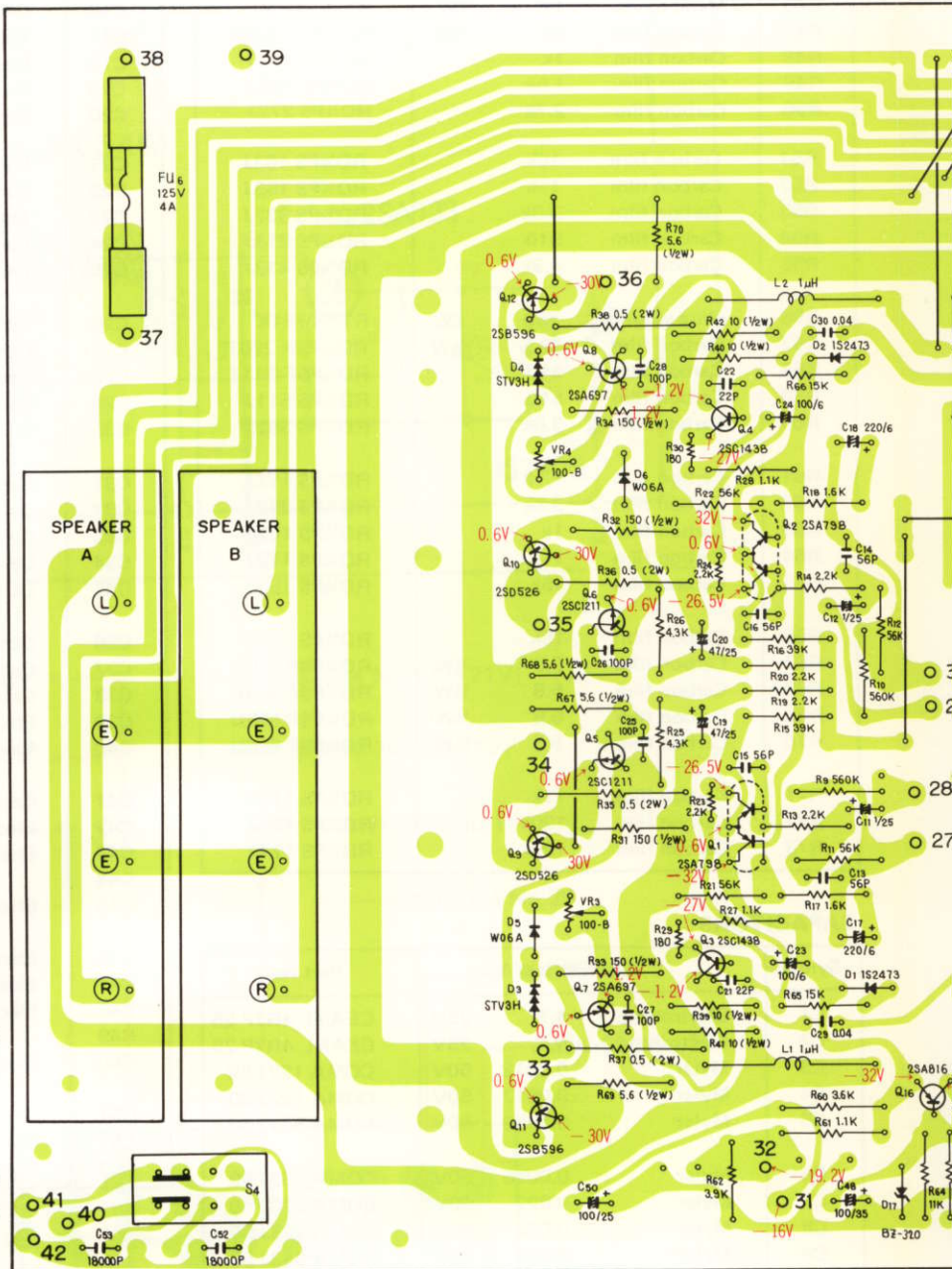

- AWM-101 No.8 (-19.2V) ← 31
- AWE-072 No.2 (-19.2V) ← 32
- AWE-072 No.6 (-16V) ← 31
- AWM-101 No.7 (-16V) ← 31

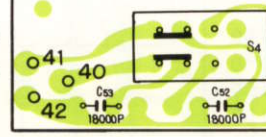

- 42 → Ground
- 41 → AWE-072 No.30
- 40 → AWE-072 No.29
- 35 → TP
- 36 → TP
- 33 → TP
- 34 → TP
- AWM-101 No.1 ← 28
- AWE-072 No.18, No.35 ← 28
- AWE-072 No.8 (+) ← 28
- AWE-072 ← 28
- AWM-101 ← 28

1

2

3

4

5

6

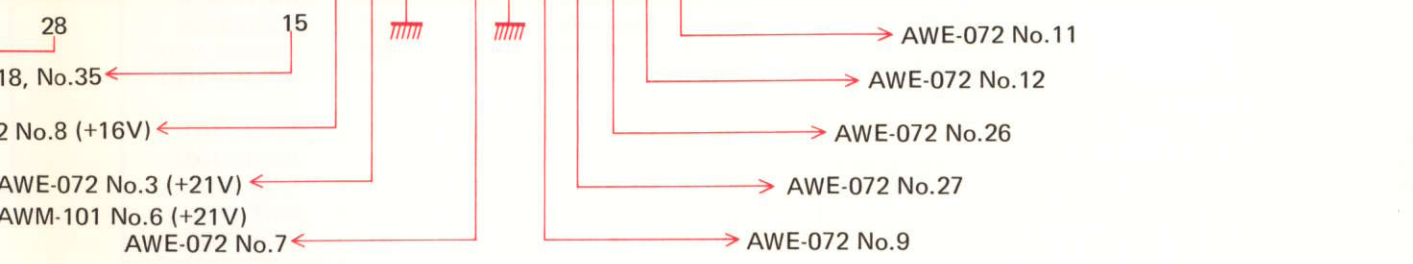
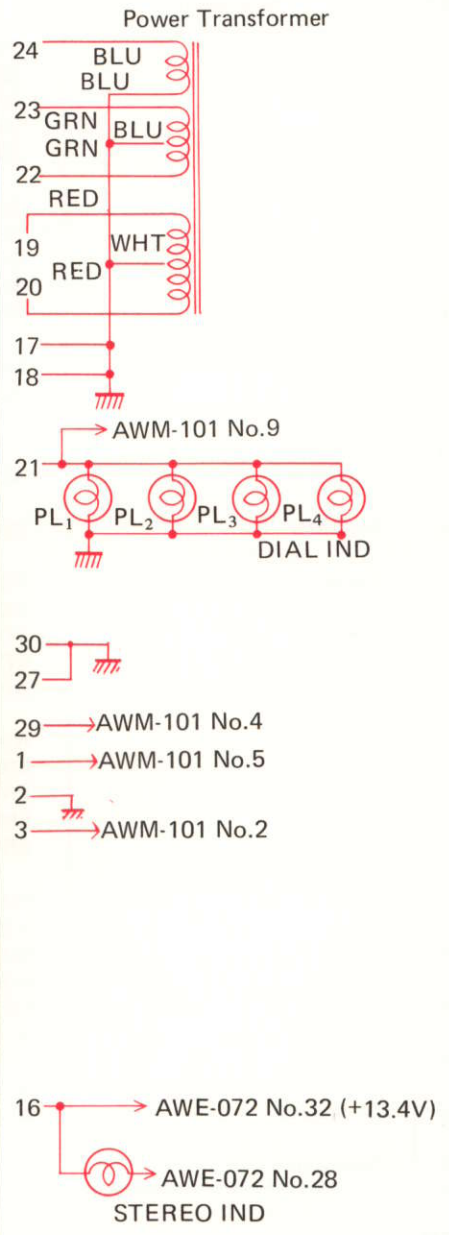
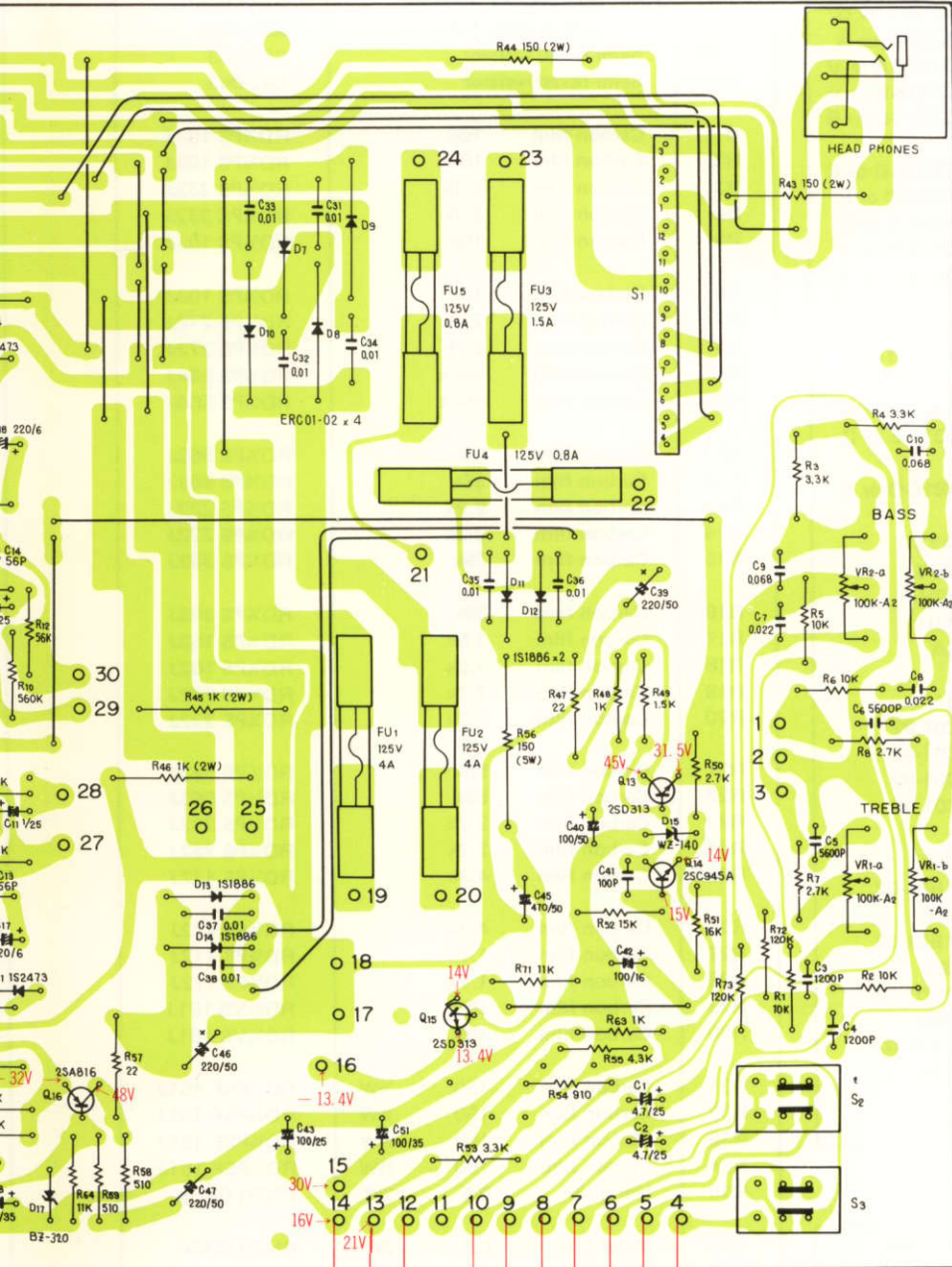

4

5

6

Parts List of AF Amplifier Assembly (AWK-056)

SEMICONDUCTORS

Symbol	Description	Part No.
Q1	Transistor	2SA798-F or G
Q2	Transistor	2SA798-F or G
Q3	Transistor	2SC1438-B or V
Q4	Transistor	2SC1438-B or V
Q5	Transistor	2SC1211-D or E
Q6	Transistor	2SC1211-D or E
Q7	Transistor	2SA697-D or E
Q8	Transistor	2SA697-D or E
Q9	Transistor	2SD526-O or Y
Q10	Transistor	2SD526-O or Y
Q11	Transistor	2SB596-O or Y
Q12	Transistor	2SB596-O or Y
Q13	Transistor	2SD313-E or D
Q14	Transistor	2SC945A-R or Q
Q15	Transistor	2SD313-E or D
Q16	Transistor	2SA816-O or Y
D1	Diode	1S2473
D2	Diode	1S2473
D3	Varistor	STV3H
D4	Varistor	STV3H
D5	Diode	W06A
D6	Diode	W06A
D7	Diode	ERC01-02
D8	Diode	ERC01-02
D9	Diode	ERC01-02
D10	Diode	ERC01-02
D11	Diode	1S1886 or S1B01-02
D12	Diode	1S1886 or S1B01-02
D13	Diode	1S1886 or S1B01-02
D14	Diode	1S1886 or S1B01-02
D15	Zener diode	WZ-140
D17	Zener diode	BZ-320

SWITCH

Symbol	Description	Part No.
S1	Rotary switch	ASA-045
S2	Push switch	ASG-092
S4	Slide switch	ASH-015

COILS

Symbol	Description	Part No.
L1	Choke coil	ATH-011
L2	Choke coil	ATH-011

RESISTORS

Symbol	Description	Part No.
VR1	Variable resistor 100kA2	ACV-138
VR2	Variable resistor 100kA2	ACV-138
VR3	Semi-fixed resistor	C92-063
VR4	Semi-fixed resistor	C92-063
R1	Carbon film 10k	RD $\frac{1}{4}$ PS 103J
R2	Carbon film 10k	RD $\frac{1}{4}$ PS 103J
R3	Carbon film 3.3k	RD $\frac{1}{4}$ PS 332J
R4	Carbon film 3.3k	RD $\frac{1}{4}$ PS 332J
R5	Carbon film 10k	RD $\frac{1}{4}$ PS 103J
R6	Carbon film 10k	RD $\frac{1}{4}$ PS 103J
R7	Carbon film 2.7k	RD $\frac{1}{4}$ PS 272J
R8	Carbon film 2.7k	RD $\frac{1}{4}$ PS 272J
R9	Carbon film 560k	RD $\frac{1}{4}$ PS 564J
R10	Carbon film 560k	RD $\frac{1}{4}$ PS 564J
R11	Carbon film 56k	RD $\frac{1}{4}$ PS 563J
R12	Carbon film 56k	RD $\frac{1}{4}$ PS 563J
R13	Carbon film 2.2k	RD $\frac{1}{4}$ PS 222J
R14	Carbon film 2.2k	RD $\frac{1}{4}$ PS 222J
R15	Carbon film 39k	RD $\frac{1}{4}$ PS 393J
R16	Carbon film 39k	RD $\frac{1}{4}$ PS 393J
R17	Carbon film 1.6k	RD $\frac{1}{4}$ PS 162J
R18	Carbon film 1.6k	RD $\frac{1}{4}$ PS 162J
R19	Carbon film 2.2k	RD $\frac{1}{4}$ PS 222J
R20	Carbon film 2.2k	RD $\frac{1}{4}$ PS 222J
R21	Carbon film 56k	RD $\frac{1}{4}$ PS 563J
R22	Carbon film 56k	RD $\frac{1}{4}$ PS 563J
R23	Carbon film 2.2k	RD $\frac{1}{4}$ PS 222J
R24	Carbon film 2.2k	RD $\frac{1}{4}$ PS 222J
R25	Carbon film 4.3k	RD $\frac{1}{4}$ PS 432J
R26	Carbon film 4.3k	RD $\frac{1}{4}$ PS 432J
R27	Carbon film 1.1k	RD $\frac{1}{4}$ PS 112J
R28	Carbon film 1.1k	RD $\frac{1}{4}$ PS 112J
R29	Carbon film 180	RD $\frac{1}{4}$ VS 181J
R30	Carbon film 180	RD $\frac{1}{4}$ VS 181J
R31	Carbon film 150 $\frac{1}{4}$ W	RD $\frac{1}{4}$ PSF 151J
R32	Carbon film 150 $\frac{1}{4}$ W	RD $\frac{1}{4}$ PSF 151J
R33	Carbon film 150 $\frac{1}{4}$ W	RD $\frac{1}{4}$ PSF 151J
R34	Carbon film 150 $\frac{1}{4}$ W	RD $\frac{1}{4}$ PSF 151J
R35	Metal film 0.5 2W	RN2H 0R5K
R36	Metal film 0.5 2W	RN2H 0R5K
R37	Metal film 0.5 2W	RN2H 0R5K
R38	Metal film 0.5 2W	RN2H 0R5K
R39	Carbon film 10 $\frac{1}{4}$ W	RD $\frac{1}{4}$ PSF 100J
R40	Carbon film 10 $\frac{1}{4}$ W	RD $\frac{1}{4}$ PSF 100J
R41	Carbon film 10 $\frac{1}{4}$ W	RD $\frac{1}{4}$ PS 100J
R42	Carbon film 10 $\frac{1}{4}$ W	RD $\frac{1}{4}$ PS 100J
R43	Metal oxide 150 2W	RS2P 151K
R44	Metal oxide 150 2W	RS2P 151K
R45	Metal oxide 1k 2W	RS2P 102K

Symbol	Description			Part No.
R46	Metal oxide	1k	2W	RS2P 102K
R47	Carbon film	22	½W	RD½PSF 220J
R48	Carbon film	1k		RD½PS 102J
R49	Carbon film	1.5k		RD½PS 152J
R50	Carbon film	2.7k		RD½PS 272J
R51	Carbon film	16k		RD½PS 163J
R52	Carbon film	15k		RD½PS 153J
R53	Carbon film	3.3k		RD½PS 332J
R54	Carbon film	910		RD½PS 911J
R55	Carbon film	4.3k		RD½PS 432J
R56	Wire wound	750	5W	RT5B 751K
R57	Carbon film	22	½W	RD½PSF 220J
R58	Carbon film	510		RD½PSF 511J
R59	Carbon film	510		RD½PS 511J
R60	Carbon film	3.6k		RD½PS 362J
R61	Carbon film	1.1k		RD½PS 112J
R62	Carbon film	3.9k		RD½PS 392J
R63	Carbon film	1k		RD½PS 102J
R64	Carbon film	11k		RD½PS 113J
R65	Carbon film	15k		RD½PS 153J
R66	Carbon film	15k		RD½PS 153J
R67	Carbon film	5.6	½W	RD½PSF 5R6J
R68	Carbon film	5.6	½W	RD½PSF 5R6J
R69	Carbon film	5.6	½W	RD½PSF 5R6J
R70	Carbon film	5.6	½W	RD½PSF 5R6J
R71	Carbon film	11k		RD½PS 113J
R72	Carbon film	120k		RD½PS 124J
R73	Carbon film	120k		RD½PS 124J

Symbol	Description			Part No.
C16	Ceramic	56p	50V	CCDSL 560K 50
C17	Electrolytic	220	6V	CEA 221P 6
C18	Electrolytic	220	6V	CEA 221P 6
C19	Electrolytic	47	25V	CEA 470P 25
C20	Electrolytic	47	25V	CEA 470P 25
C21	Ceramic	22p	50V	CCDSL 220K 50
C22	Ceramic	22p	50V	CCDSL 220K 50
C23	Electrolytic	100	6V	CEA 101P 6
C24	Electrolytic	100	6V	CEA 101P 6
C25	Ceramic	100p	50V	CCDSL 101K 50
C26	Ceramic	100p	50V	CCDSL 101K 50
C27	Ceramic	100p	50V	CCDSL 101K 50
C28	Ceramic	100p	50V	CCDSL 101K 50
C29	Ceramic	0.04	50V	CKDYF 403Z 50
C30	Ceramic	0.04	50V	CKDYF 403Z 50
C31	Ceramic	0.01	150V	ACG-004-0
C32	Ceramic	0.01	150V	ACG-004-0
C33	Ceramic	0.01	150V	ACG-004-0
C34	Ceramic	0.01	150V	ACG-004-0
C35	Ceramic	0.01	150V	ACG-004-0
C36	Ceramic	0.01	150V	ACG-004-0
C37	Ceramic	0.01	150V	ACG-004-0
C38	Ceramic	0.01	150V	ACG-004-0
C39	Electrolytic	220	50V	CEA 221P 50
C40	Electrolytic	100	50V	CEA 101P 50
C41	Ceramic	100p	50V	CCDSL 101K 50
C42	Electrolytic	100	16V	CEA 101P 16
C43	Electrolytic	100	25V	CEA 101P 25
C44
C45	Electrolytic	470	50V	CEA 471P 50
C46	Electrolytic	220	50V	CEA 221P 50
C47	Electrolytic	220	50V	CEA 221P 50
C48	Electrolytic	100	35V	CEA 101P 35
C49
C50	Electrolytic	100	25V	CEA 101P 25
C51	Electrolytic	100	35V	CEA 101P 35
C52	Mylar	0.018	50V	CQMA 183J 50
C53	Mylar	0.018	50V	CQMA 183J 50

CAPACITORS

Symbol	Description			Part No.
C1	Electrolytic	4.7	25V	CEANL 4R7P 25
C2	Electrolytic	4.7	25V	CEANL 4R7P 25
C3	Mylar	0.0012	50V	CQMA 122J 50
C4	Mylar	0.0012	50V	CQMA 122J 50
C5	Mylar	0.0056	50V	CQMA 562J 50
C6	Mylar	0.0056	50V	CQMA 562J 50
C7	Mylar	0.022	50V	CQMA 223J 50
C8	Mylar	0.022	50V	CQMA 223J 50
C9	Mylar	0.068	50V	CQMA 683J 50
C10	Mylar	0.068	50V	CQMA 683J 50
C11	Electrolytic	1	25V	CSZA 010M 25
C12	Electrolytic	1	25V	CSZA 010M 25
C13	Ceramic	56p	50V	CCDSL 560K 50
C14	Ceramic	56p	50V	CCDSL 560K 50
C15	Ceramic	56p	50V	CCDSL 560K 50

12.5 AF MUTING ASSEMBLY (AWM-101)

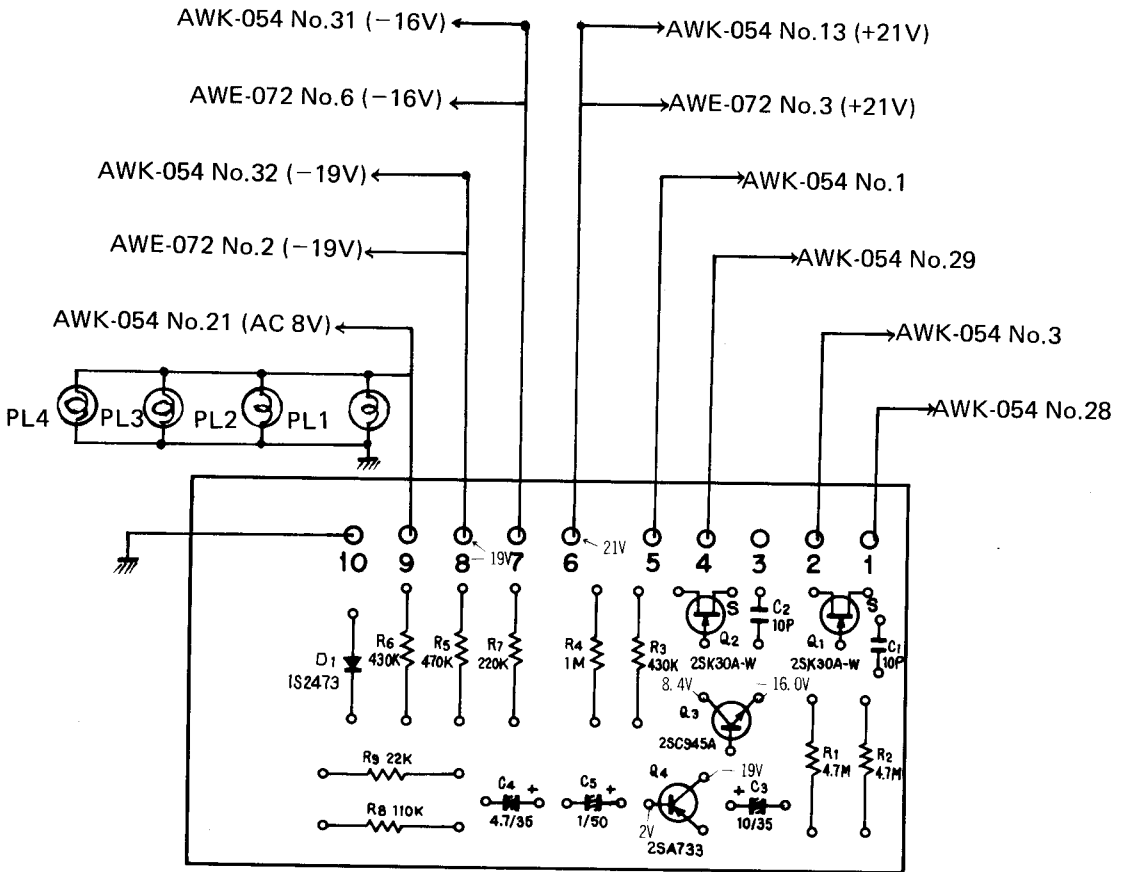
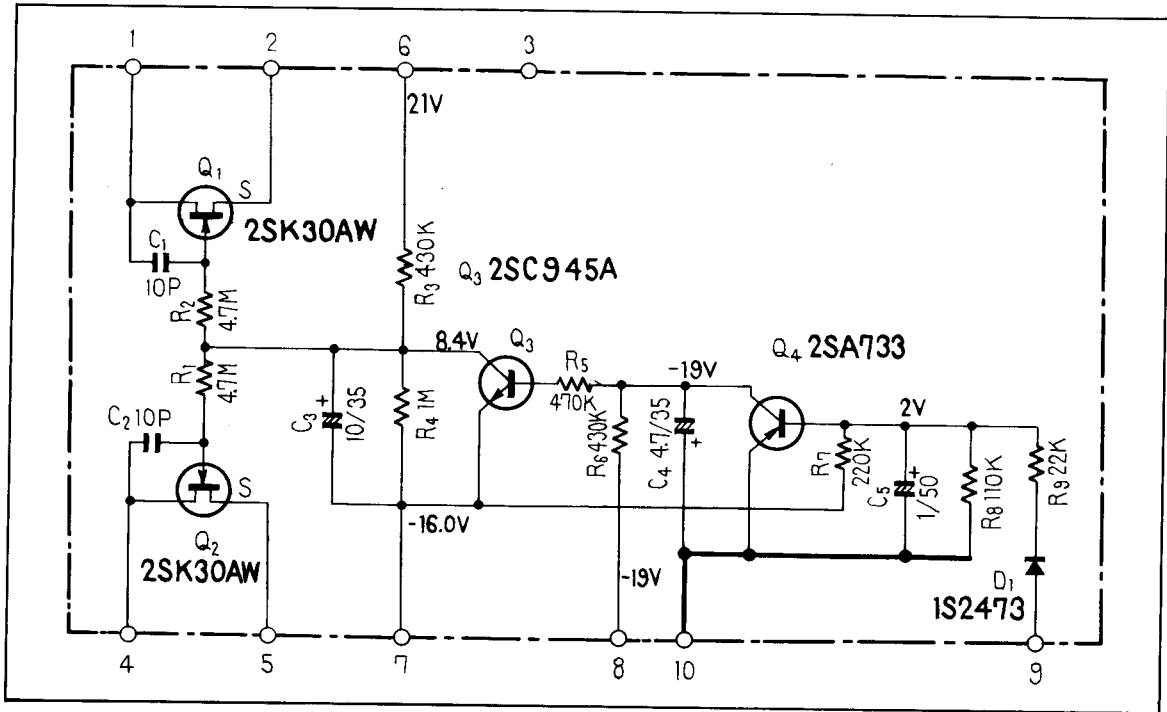

Parts List of AF MUTING Assembly (AWM-101)

SEMICONDUCTORS

Symbol	Description	Part No.
Q1	Transistor	2SK 30AW*Y or GR
Q2	Transistor	2SK 30AW-Y or GR
Q3	Transistor	2SC 945A-Q or R
Q4	Transistor	2SA 733-Q or R
D1	Diode	1S 2473

RESISTORS

Symbol	Description	Part No.
R1	Carbon film 4.7M	RD¼PS 475J
R2	Carbon film 4.7M	RD¼PS 475J
R3	Carbon film 430k	RD¼PS 434J
R4	Carbon film 1M	RD¼PS 105J
R5	Carbon film 470k	RD¼PS 474J
R6	Carbon film 430k	RD¼PS 434J
R7	Carbon film 220k	RD¼PS 224J
R8	Carbon film 110k	RD¼PS 114J
R9	Carbon film 22k	RD¼PS 223J

CAPACITORS

Symbol	Description	Part No.
C1	Ceramic 100p 50V	CCDSL 100K 50
C2	Ceramic 100p 50V	CCDSL 100K 50
C3	Electrolytic 10 35V	CEA 100P 35
C4	Electrolytic 4.7 35V	CEA 4R7P 35
C5	Electrolytic 0.1 50	CEA 010P 50

13. PACKING

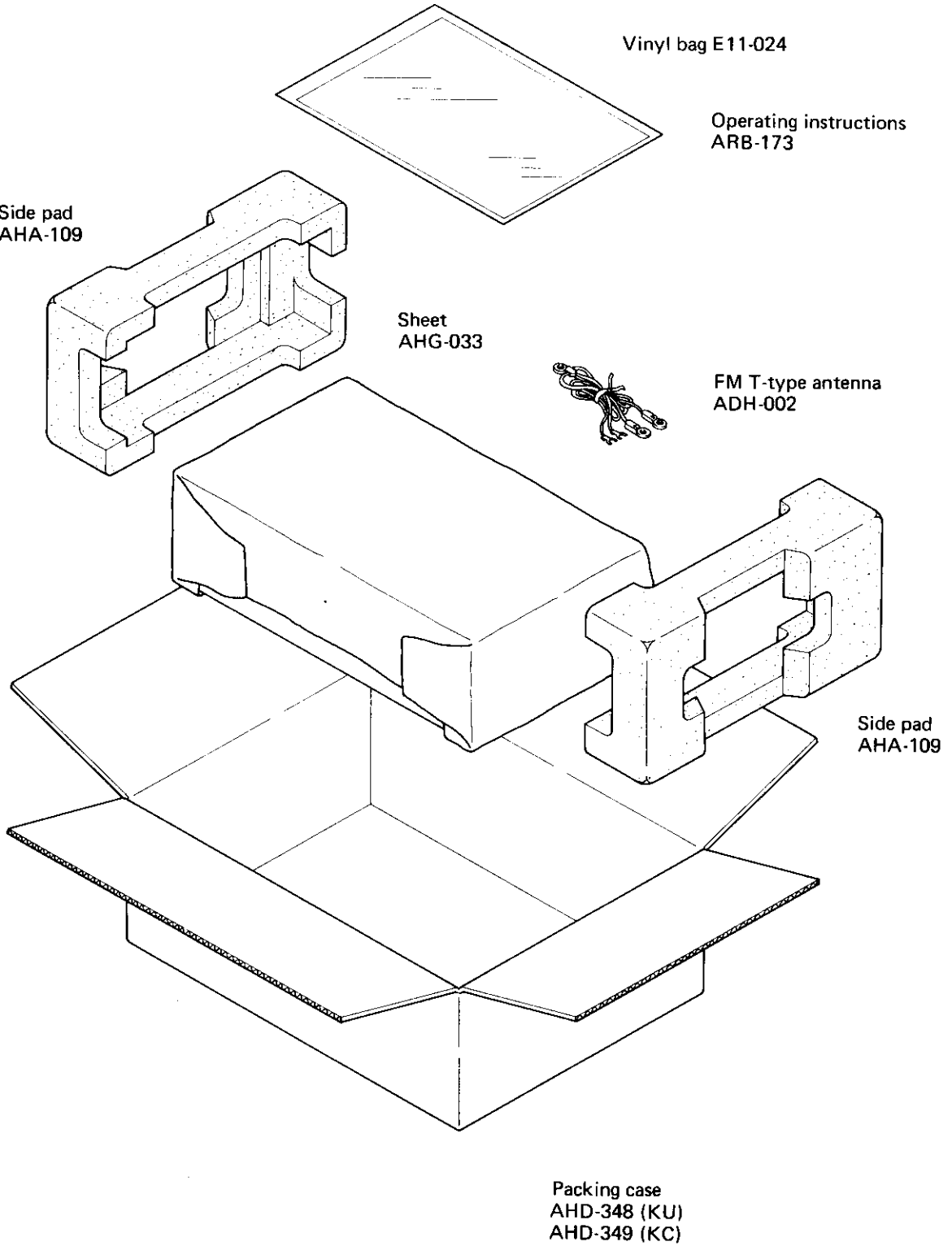

AM/FM STEREO RECEIVER

SX-550

KU, HG, S

Additional

Service Manual

NOTE:

This leaflet provides the description of the parts applies only to the KU, HG, S model.
For detailed please refer to the Service Manual of SX-550.

2. SX-550 HG MODEL

2.1 SCHEMATIC DIAGRAM

A

B

C

D

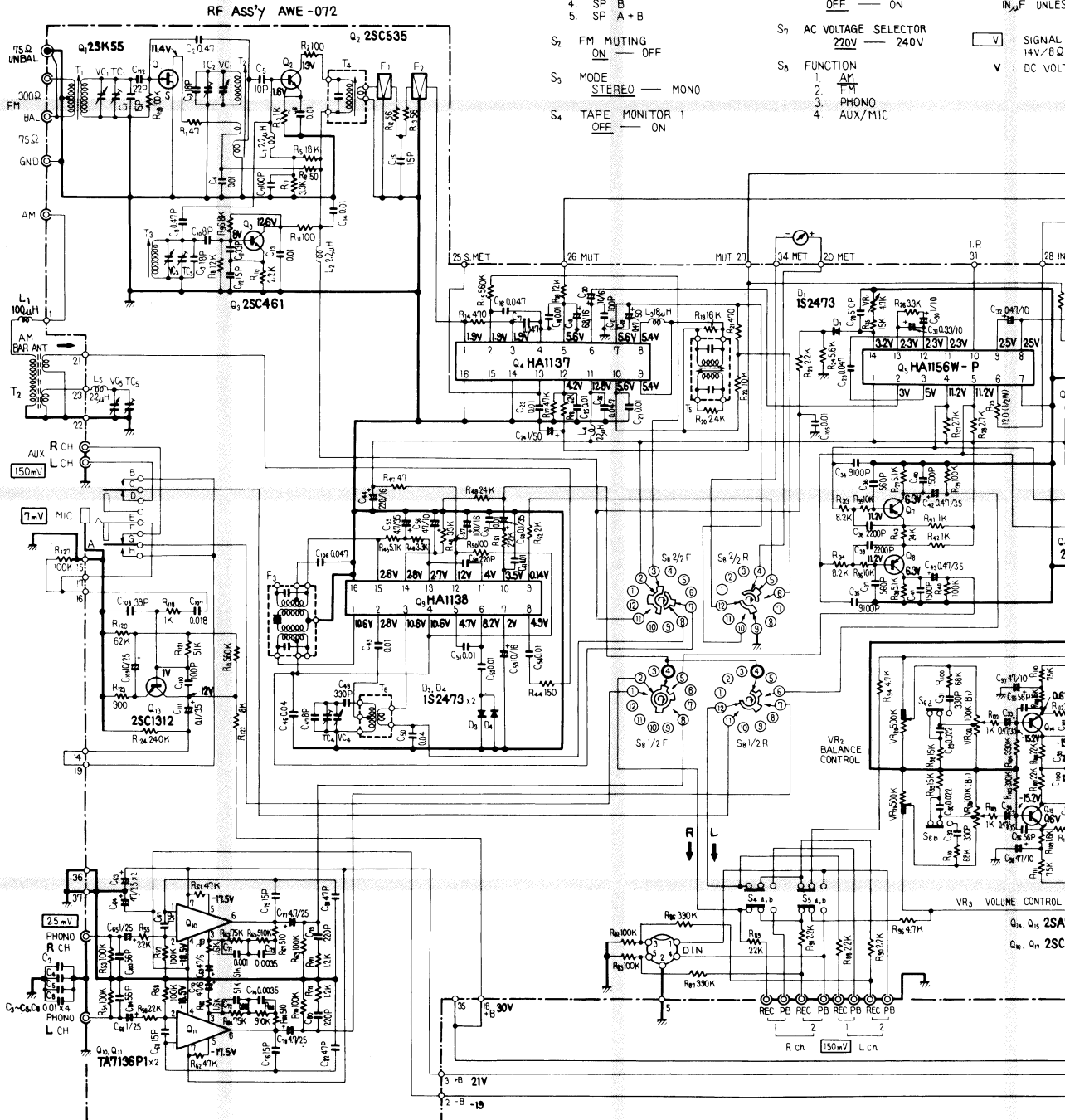

SWITCHES:

- S₁ SPEAKERS
- 1. POWER OFF
- 2. SP A
- 3. SP OFF
- 4. SP B
- 5. SP A + B

- S₂ FM MUTING
- ON OFF

- S₃ MODE
- STEREO MONO

- S₄ TAPE MONITOR 1
- OFF ON

- S₅ TAPE MONITOR 2
- OFF ON

- S₆ LOUDNESS
- OFF ON

- S₇ AC VOLTAGE SELECTOR
- 220V 240V

- S₈ FUNCTION
- 1. AM
- 2. FM
- 3. PHONO
- 4. AUX/MIC

RESISTORS:
IN OHM, 1/4
OTHERWISE

CAPACITORS:
IN μF UNLESS

V SIGNAL
14V/8Ω
V DC VOLT

4

5

6

A

B

C

D

RESISTORS:
IN OHM, 1/4W, ±5% TOLERANCE UNLESS
OTHERWISE NOTED K: KΩ M: MΩ

CAPACITORS:
IN μF UNLESS OTHERWISE NOTED P: pF

V: SIGNAL VOLTAGE NECESSARY OBTAINING
14V/8Ω OUTPUT POWER (1K Hz)

V: DC VOLTAGE AT NO INPUT SIGNAL.

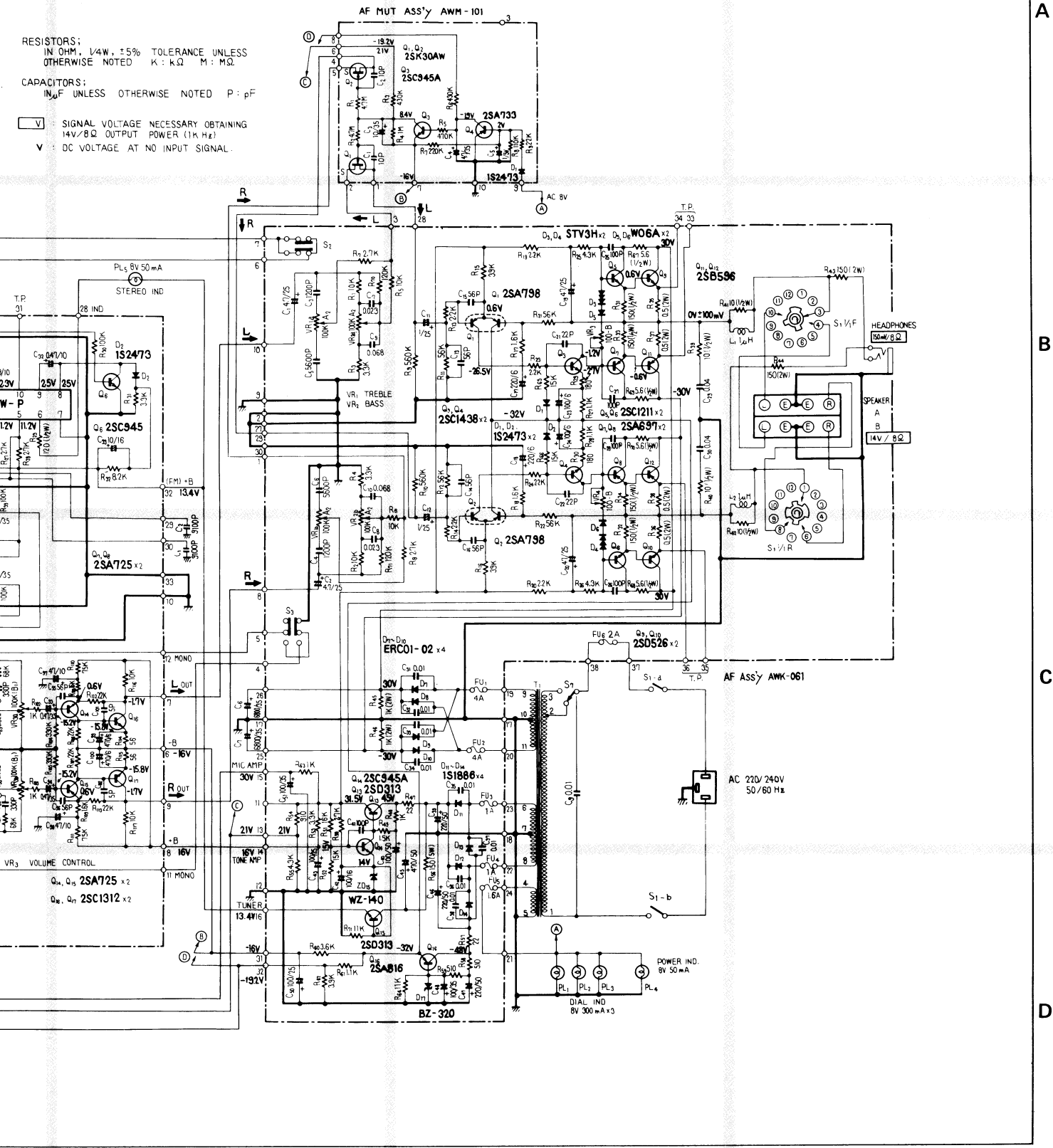

4

5

6

4

2.2 AF AMPLIFIER ASSEMBLY (AWK-061)

A

B

C

D

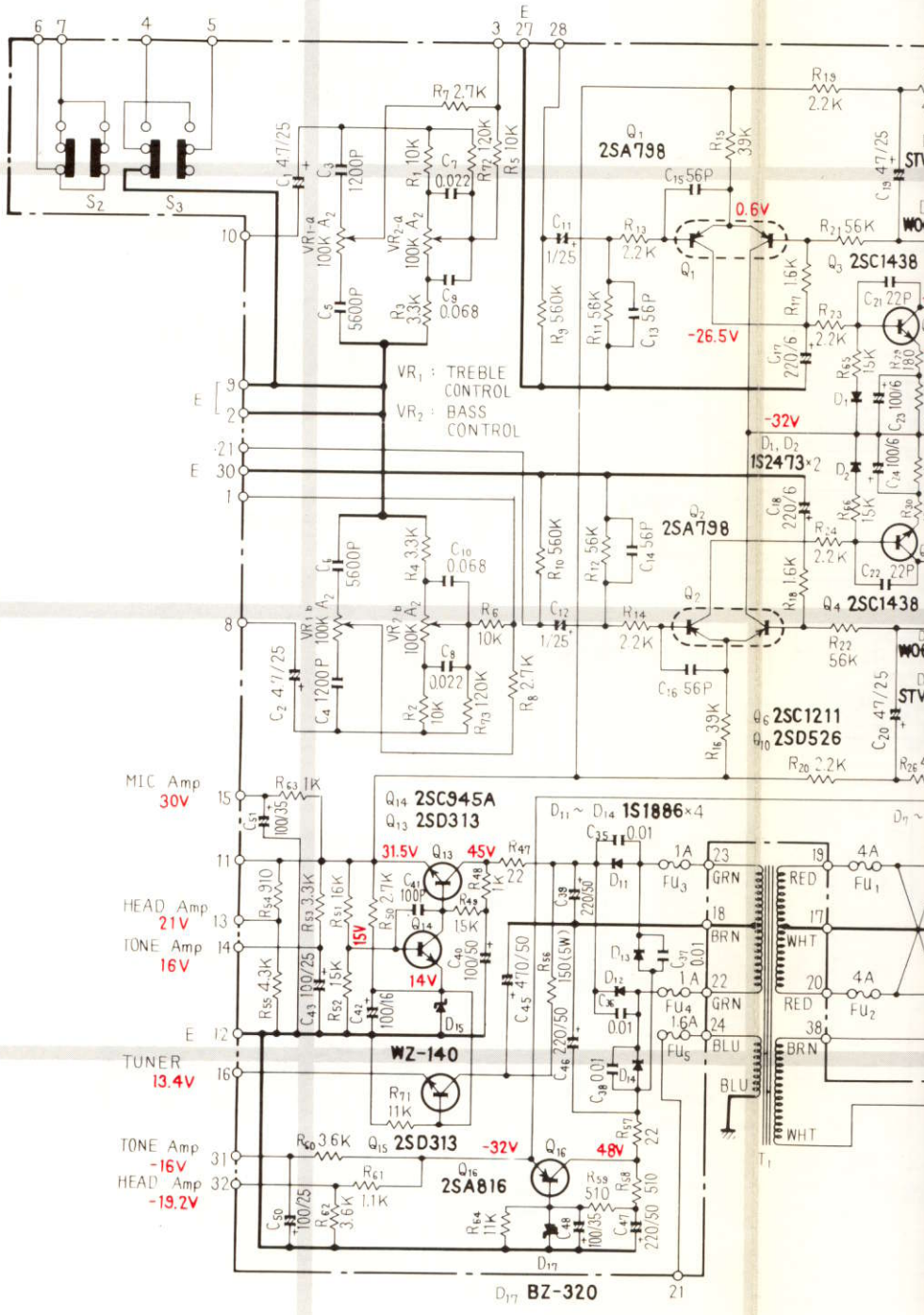

A

B

C

D

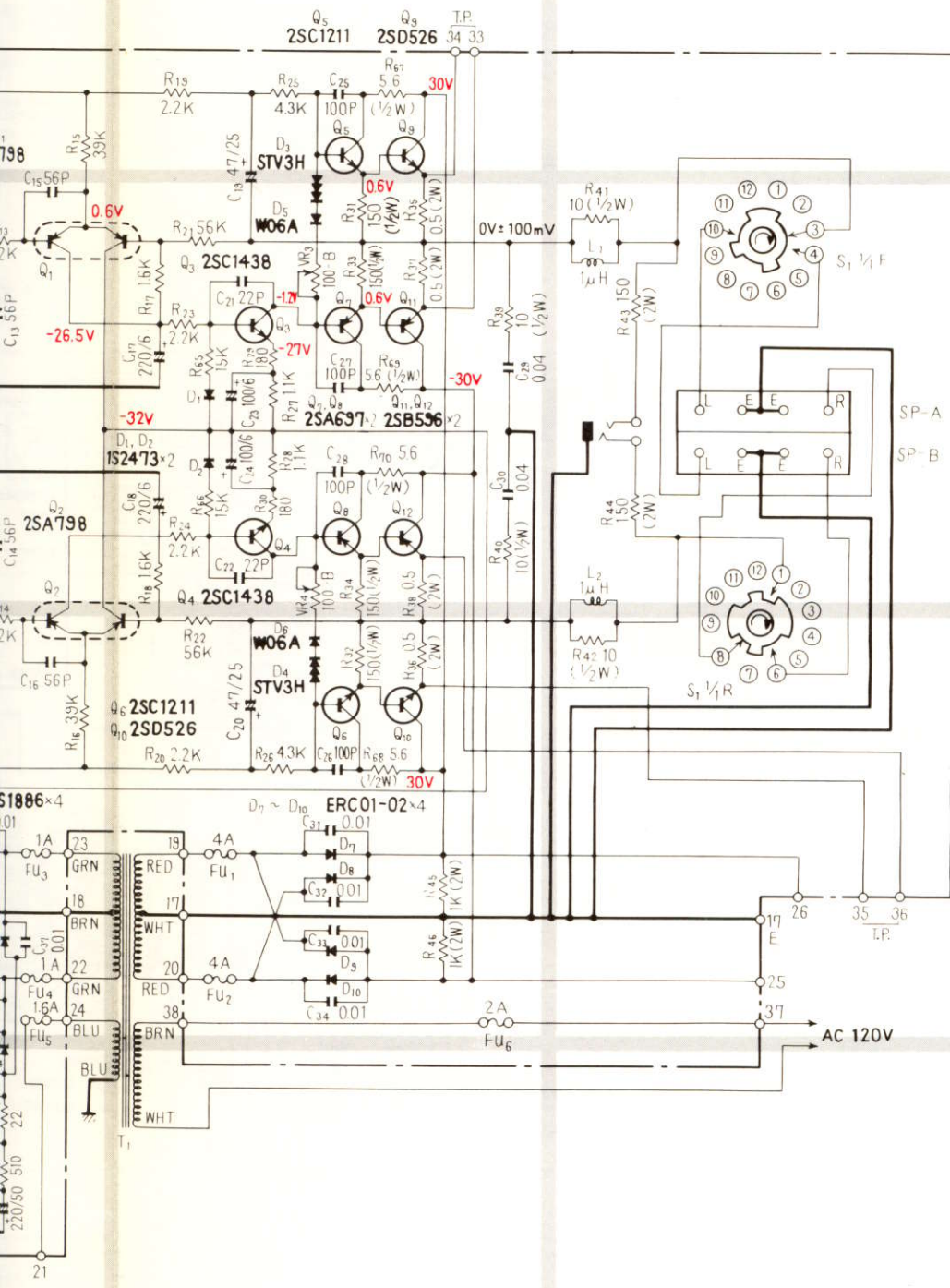

1

2

3

A

B

C

D

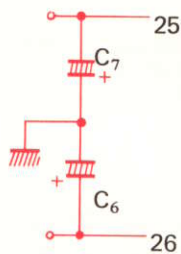
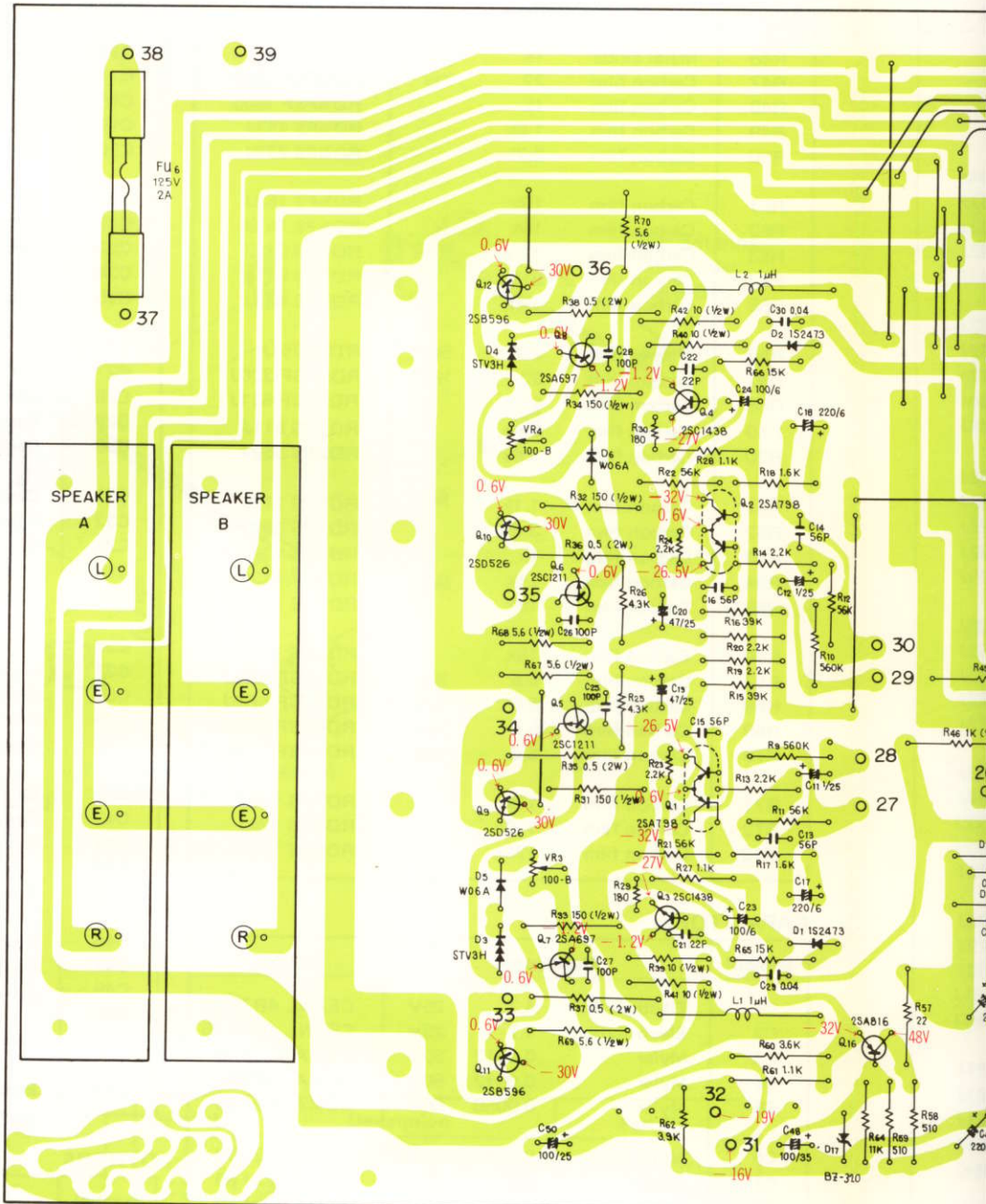

- AWM-101 No. 8 (-19.2V) ←
- AWE-072 No.2 (-19.2V) ←
- AWE-072 No.6 (-16V) ←
- AWM-101 No.7 (-16V) ←

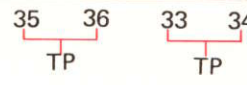

- AWM-101 No.1 ←
- AWE-072 No.18, No.35 ←
- AWE-072 No.8 (+16V) ←
- AWE-072 No.3 (+21V) ←
- AWM-101 No.6 (+21V) ←
- AWE-072 No. ←

1

2

3

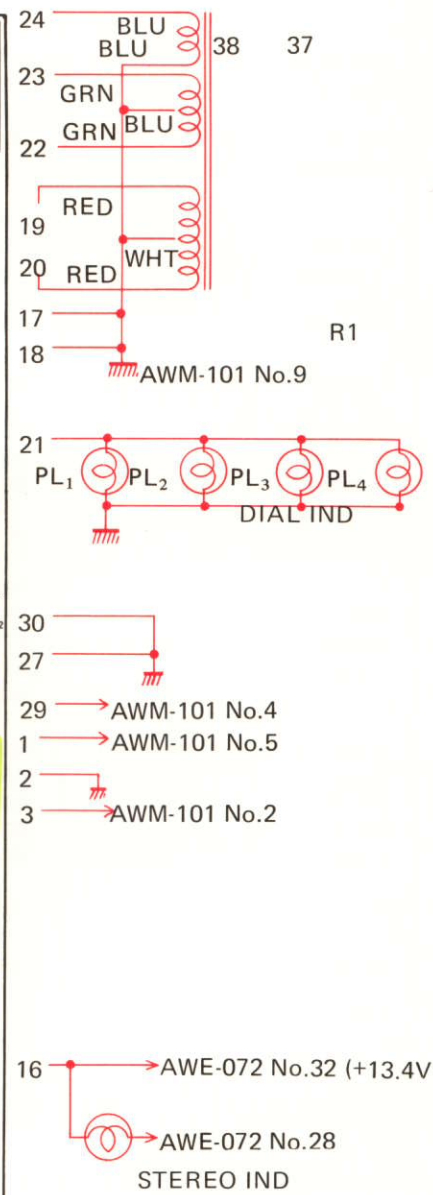
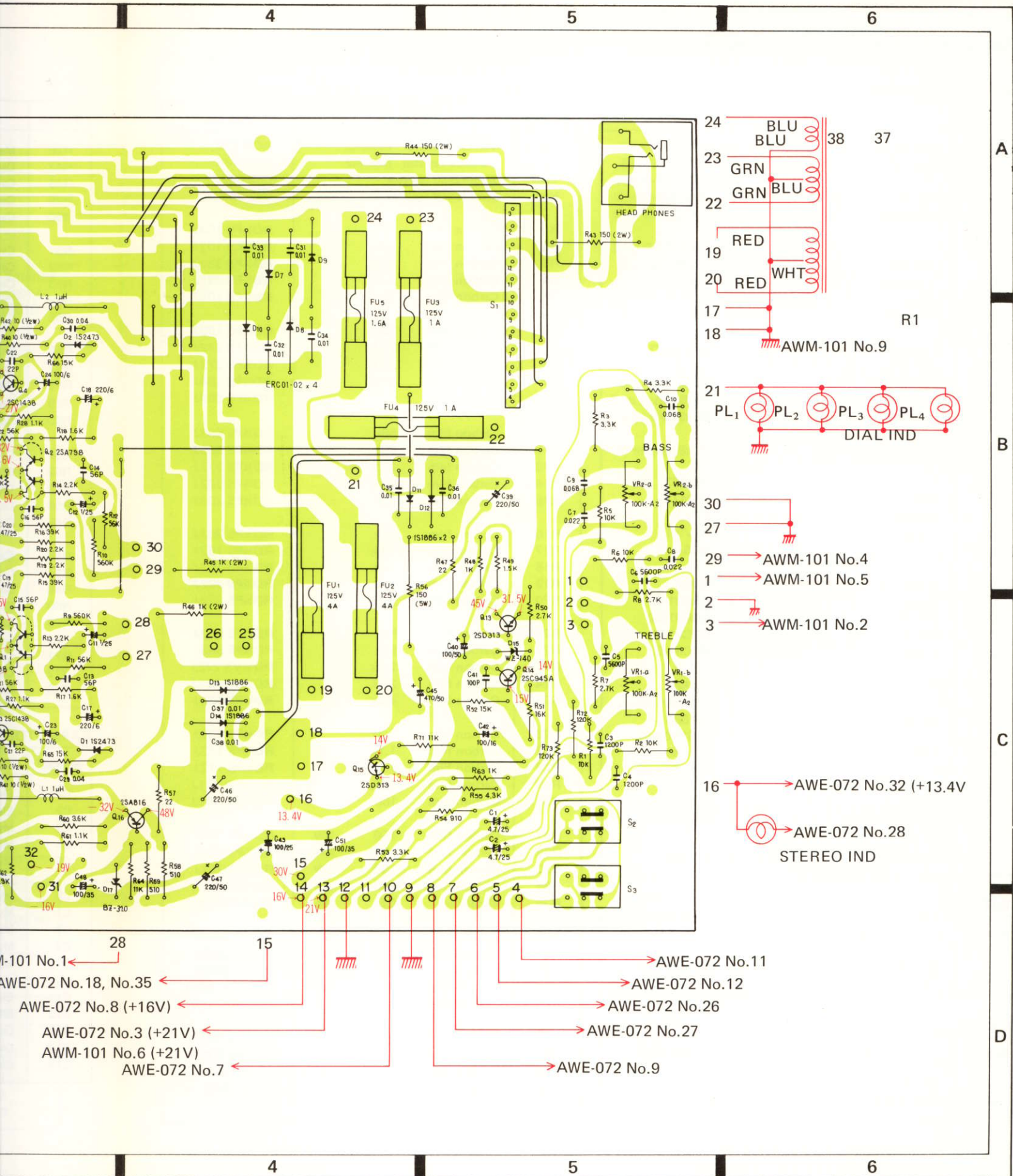

- AWM-101 No.1
- AWE-072 No.18, No.35
- AWE-072 No.8 (+16V)
- AWE-072 No.3 (+21V)
- AWM-101 No.6 (+21V)
- AWE-072 No.7
- AWE-072 No.11
- AWE-072 No.12
- AWE-072 No.26
- AWE-072 No.27
- AWE-072 No.9

A
B
C
D
E

Parts List of AF Amplifier Assembly (AWK-061)

SEMICONDUCTORS

Symbol	Description	Part No.
Q1	Transistor	2SA798-F or G
Q2	Transistor	2SA798-F or G
Q3	Transistor	2SC1438-B or V
Q4	Transistor	2SC1438-B or V
Q5	Transistor	2SC1211-D or E
Q6	Transistor	2SC1211-D or E
Q7	Transistor	2SA697-D or E
Q8	Transistor	2SA697-D or E
Q9	Transistor	2SD526-O or Y
Q10	Transistor	2SD526-O or Y
Q11	Transistor	2SB596-O or Y
Q12	Transistor	2SB596-O or Y
Q13	Transistor	2SD313-E or D
Q14	Transistor	2SC945A-R or Q
Q15	Transistor	2SD313-E or D
Q16	Transistor	2SA816-O or Y
D1	Diode	1S2473
D2	Diode	1S2473
D3	Varistor	STV3H
D4	Varistor	STV3H
D5	Diode	W06A
D6	Diode	W06A
D7	Diode	ERC01-02
D8	Diode	ERC01-02
D9	Diode	ERC01-02
D10	Diode	ERC01-02
D11	Diode	1S1886 or S1B01-02
D12	Diode	1S1886 or S1B01-02
D13	Diode	1S1886 or S1B01-02
D14	Diode	1S1886 or S1B01-02
D15	Zener diode	WZ-140
D17	Zener diode	BZ-320

SWITCHES

Symbol	Description	Part No.
S1	Rotary switch	ASA-042
S2	Push switch	ASG-092

COILS

Symbol	Description	Part No.
L1	Choke coil	ATH-011
L2	Choke coil	ATH-011

RESISTORS

Symbol	Description	Part No.
VR1	Variable resistor 100kA2	ACV-138
VR2	Variable resistor 100kA2	ACV-138
VR3	Semi-fixed resistor	C92-063
VR4	Semi-fixed resistor	C92-063
R1	Carbon film 10k	RD½PS 103J
R2	Carbon film 10k	RD½PS 103J
R3	Carbon film 3.3k	RD½PS 332J
R4	Carbon film 3.3k	RD½PS 332J
R5	Carbon film 10k	RD½PS 103J
R6	Carbon film 10k	RD½PS 103J
R7	Carbon film 2.7k	RD½PS 272J
R8	Carbon film 2.7k	RD½PS 272J
R9	Carbon film 560k	RD½PS 564J
R10	Carbon film 560k	RD½PS 564J
R11	Carbon film 56k	RD½PS 563J
R12	Carbon film 56k	RD½PS 563J
R13	Carbon film 2.2k	RD½PS 222J
R14	Carbon film 2.2k	RD½PS 222J
R15	Carbon film 39k	RD½PS 393J
R16	Carbon film 39k	RD½PS 393J
R17	Carbon film 1.6k	RD½PS 162J
R18	Carbon film 1.6k	RD½PS 162J
R19	Carbon film 2.2k	RD½PS 222J
R20	Carbon film 2.2k	RD½PS 222J
R21	Carbon film 56k	RD½PS 563J
R22	Carbon film 56k	RD½PS 563J
R23	Carbon film 2.2k	RD½VS 222J
R24	Carbon film 2.2k	RD½VS 222J
R25	Carbon film 4.3k	RD½PS 432J
R26	Carbon film 4.3k	RD½PS 432J
R27	Carbon film 1.1k	RD½PS 112J
R28	Carbon film 1.1k	RD½PS 112J
R29	Carbon film 180	RD½VS 181J
R30	Carbon film 180	RD½VS 181J
R31	Carbon film 150 ½W	RD½PS 151J
R32	Carbon film 150 ½W	RD½PS 151J
R33	Carbon film 150 ½W	RD½PS 151J
R34	Carbon film 150 ½W	RD½PS 151J
R35	Metal film 0.5 2W	RN2H 0R5K
R36	Metal film 0.5 2W	RN2H 0R5K
R37	Metal film 0.5 2W	RN2H 0R5K
R38	Metal film 0.5 2W	RN2H 0R5K
R39	Carbon film 10 ½W	RD½PSF 100J
R40	Carbon film 10 ½W	RD½PSF 100J
R41	Carbon film 10 ½W	RD½PS 100J
R42	Carbon film 10 ½W	RD½PS 100J
R43	Metal oxide 150 2W	RS2P 151K
R44	Metal oxide 150 2W	RS2P 151K
R45	Metal oxide 1k 2W	RS2P 102K

Symbol	Description			Part No.
R46	Metal oxide	1k	2W	RS2P 102K
R47	Carbon film	22	½W	RD½PSF 220J
R48	Carbon film	1k		RD½PSF 102J
R49	Carbon film	1.5k		RD½PS 152J
R50	Carbon film	2.7k		RD½PS 272J
R51	Carbon film	16k		RD½PS 163J
R52	Carbon film	15k		RD½PS 153J
R53	Carbon film	3.3k		RD½PS 332J
R54	Carbon film	910		RD½PS 911J
R55	Carbon film	4.3k		RD½PS 432J
R56	Wire wound	750	5W	RT5B 751K
R57	Carbon film	22	½W	RD½PSF 220J
R58	Carbon film	510		RD½PSF 511J
R59	Carbon film	510		RD½PS 511J
R60	Carbon film	3.6k		RD½PS 362J
R61	Carbon film	1.1k		RD½PS 112J
R62	Carbon film	3.9k		RD½PS 392J
R63	Carbon film	1k		RD½PS 102J
R64	Carbon film	11k		RD½PS 113J
R65	Carbon film	15k		RD½PS 153J
R66	Carbon film	15k		RD½PS 153J
R67	Carbon film	5.6	½W	RD½PSF 5R6J
R68	Carbon film	5.6	½W	RD½PSF 5R6J
R69	Carbon film	5.6	½W	RD½PSF 5R6J
R70	Carbon film	5.6	½W	RD½PSF 5R6J
R71	Carbon film	11k		RD½PS 113J
R72	Carbon film	120k		RD½PS 124J
R73	Carbon film	120k		RD½PS 124J

CAPACITORS

Symbol	Description			Part No.
C1	Electrolytic	4.7	25V	CEANL 4R7P 25
C2	Electrolytic	4.7	25V	CEANL 4R7P 25
C3	Mylar	0.0012	50V	CQMA 122J 50
C4	Mylar	0.0012	50V	CQMA 122J 50
C5	Mylar	0.0056	50V	CQMA 562J 50
C6	Mylar	0.0056	50V	CQMA 562J 50
C7	Mylar	0.022	50V	CQMA 223J 50
C8	Mylar	0.022	50V	CQMA 223J 50
C9	Mylar	0.068	50V	CQMA 683J 50
C10	Mylar	0.068	50V	CQMA 683J 50
C11	Electrolytic	1	25V	CSZA 010M 25
C12	Electrolytic	1	25V	CSZA 010M 25
C13	Ceramic	56p	50V	CCDSL 560K 50
C14	Ceramic	56p	50V	CCDSL 560K 50
C15	Ceramic	56p	50V	CCDSL 560K 50

Symbol	Description			Part No.
C16	Ceramic	56p	50V	CCDSL 560K 50
C17	Electrolytic	220	6V	CEA 221P 6
C18	Electrolytic	220	6V	CEA 221P 6
C19	Electrolytic	47	25V	CEA 470P 25
C20	Electrolytic	47	25V	CEA 470P 25
C21	Ceramic	22p	50V	CCDSL 220K 50
C22	Ceramic	22p	50V	CCDSL 220K 50
C23	Electrolytic	100	6V	CEA 101P 6
C24	Electrolytic	100	6V	CEA 101P 6
C25	Ceramic	100p	50V	CCDSL 101K 50
C26	Ceramic	100p	50V	CCDSL 101K 50
C27	Ceramic	100p	50V	CCDSL 101K 50
C28	Ceramic	100p	50V	CCDSL 101K 50
C29	Ceramic	0.04	50V	CKDYF 403Z 50
C30	Ceramic	0.04	50V	CKDYF 403Z 50
C31	Ceramic	0.01	150V	ACG-004
C32	Ceramic	0.01	150V	ACG-004
C33	Ceramic	0.01	150V	ACG-004
C34	Ceramic	0.01	150V	ACG-004
C35	Ceramic	0.01	150V	ACG-004
C36	Ceramic	0.01	150V	ACG-004-0
C37	Ceramic	0.01	150V	ACG-004-0
C38	Ceramic	0.01	150V	ACG-004-0
C39	Electrolytic	220	50V	CEA 221P 50
C40	Electrolytic	100	50V	CEA 101P 50
C41	Ceramic	100p	50V	CCDSL 101K 50
C42	Electrolytic	100	16V	CEA 101P 16
C43	Electrolytic	100	25V	CEA 101P 25
C44
C45	Electrolytic	470	50V	CEA 471P 50
C46	Electrolytic	220	50V	CEA 221P 50
C47	Electrolytic	220	50V	CEA 221P 50
C48	Electrolytic	100	35V	CEA 101P 35
C49
C50	Electrolytic	100	25V	CEA 101P 25
C51	Electrolytic	100	35V	CEA 101P 35

OTHERS

Symbol	Description	Part No.
	Fuse clip	AKR-010

2.3 REAR PANEL

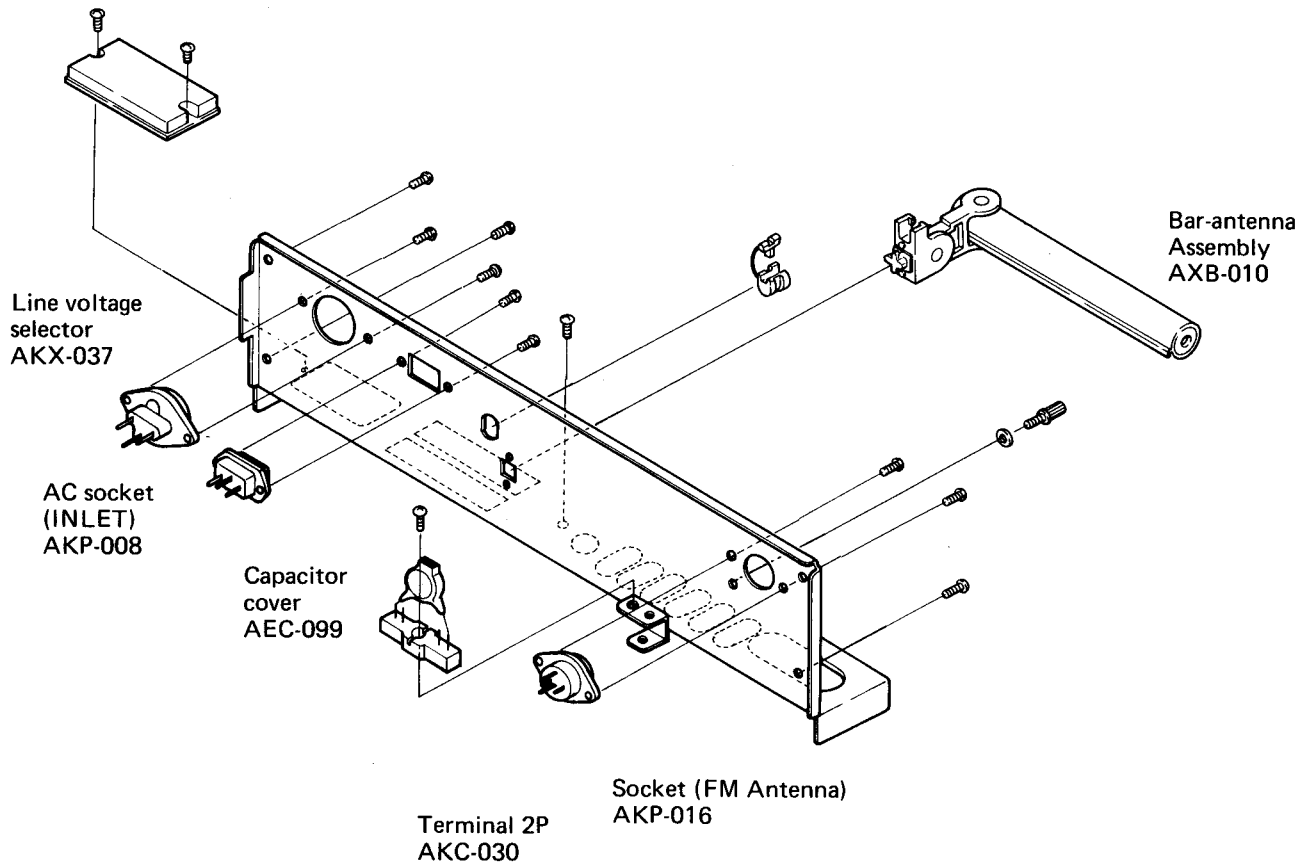

2.4 MISCELLANEOUS PARTS LIST

Only components that differ from those used in the KC model are listed below.

FUSES

Symbol	Description	Part No.
FU1	Fuse 4A	AEK-400
FU2	Fuse 4A	AEK-400
FU3	Fuse 1A	AEK-402
FU4	Fuse 1A	AEK-402
FU5	Fuse 1.6A	AEK-405
FU6	Fuse 2A	AEK-017

CAPACITORS

Symbol	Description	Part No.
C1	Ceramic 0.01 50V	CKDYA 103Z 50
C2	Ceramic 0.01 50V	CKDYA 103Z 50
C9	Ceramic 0.01 250V	ACG-001

OTHERS

Symbol	Description	Part No.
	Top plate	ANE-131
	AF amplifier assembly	AWK-061
	Operating instructions (English)	ARB-183
	(German/French)	ARD-093
	Packing case	AHD-350

COIL AND TRANSFORMER

Symbol	Description	Part No.
T1	Power transformer	ATT-327
L1	RF choke-coil 101k	T24-030

3. SX-550/S MODEL

3.1 REAR PANEL

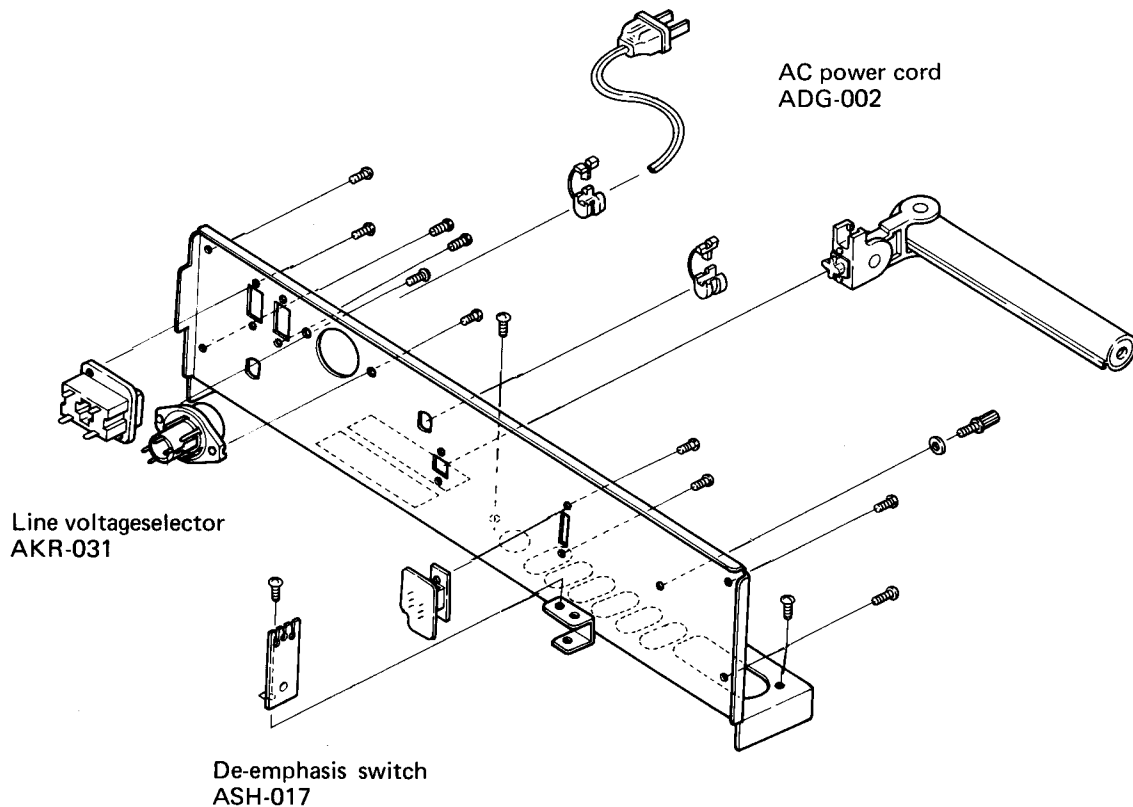

3.2 MISCELLANEOUS PARTS LIST

Only components that differ from those used in the KC model are listed below.

FUSE

Symbol	Description	Part No.
FU6	Fuse 4A (110V, 120V)	AEK-100
	2A (220V, 240V)	AEK-103

CAPACITORS

Symbol	Description	Part No.
C1	Ceramic 0.01 250V	ACG-001
C2	Ceramic 0.01 250V	ACG-001

OTHERS

Symbol	Description	Part No.
T1	Top plate	ANE-131
	AF amplifier assembly	AWK-059
	Power transformer	ATT-323
	Capacitor cover	AEC-099
	Vinyl bage	EII-033
	Fuse 2A	AEK-103
	Fuse 4A	AEK-100
	Operating instructions	ARB-182
Packing case	AHD-348	

3.3 SCHEMATIC DIAGRAM

A

B

C

D

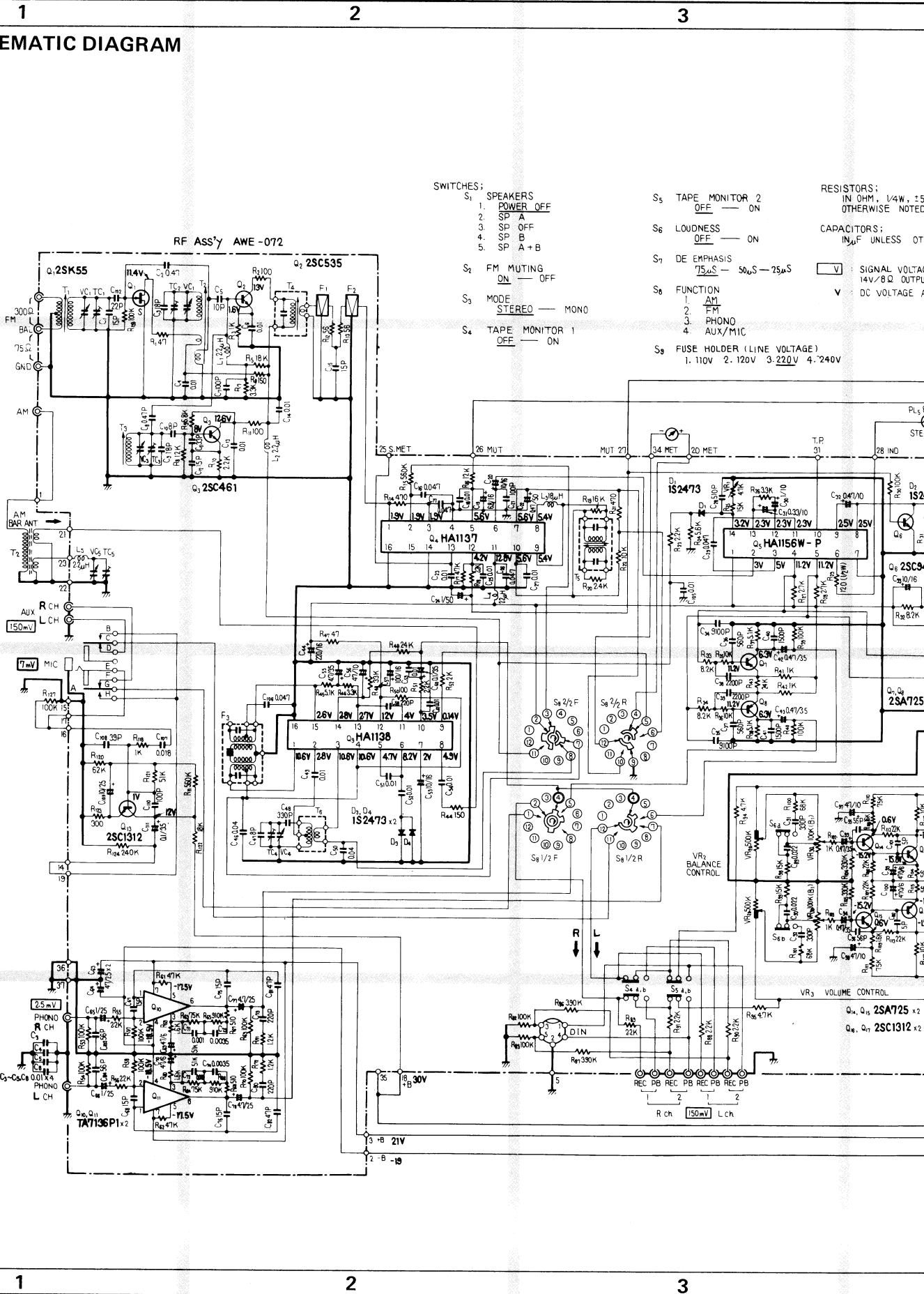

SWITCHES:

- S1 SPEAKERS POWER OFF
- 2 SP A
- 3 SP OFF
- 4 SP B
- 5 SP A+B
- S2 FM MUTING ON — OFF
- S3 MODE STEREO — MONO
- S4 TAPE MONITOR 1 OFF — ON

- S5 TAPE MONITOR 2 OFF — ON
- S6 LOUDNESS OFF — ON
- S7 DE EMPHASIS 75μS — 50μS — 25μS
- S8 FUNCTION 1. AM 2. FM 3. PHONO 4. AUX/MIC
- S9 FUSE HOLDER (LINE VOLTAGE) 1. 110V 2. 120V 3. 220V 4. 240V

RESISTORS: IN OHM, 1/4W, 1% OTHERWISE NOTED

CAPACITORS: IN μF UNLESS OTHERWISE NOTED

⊖ SIGNAL VOLTAGE 14V/B.Q. OUTPUT

⊖ DC VOLTAGE

Q4, Q5 2SA725 x2
Q6, Q7 2SC1312 x2

4

5

6

RESISTORS:
IN OHM, 1/4W, ±5% TOLERANCE UNLESS
OTHERWISE NOTED K: kΩ M: MΩ

CAPACITORS:
IN μF UNLESS OTHERWISE NOTED P: pF

V: SIGNAL VOLTAGE NECESSARY OBTAINING
14V/8Ω OUTPUT POWER (1K Hz)

V: DC VOLTAGE AT NO INPUT SIGNAL.

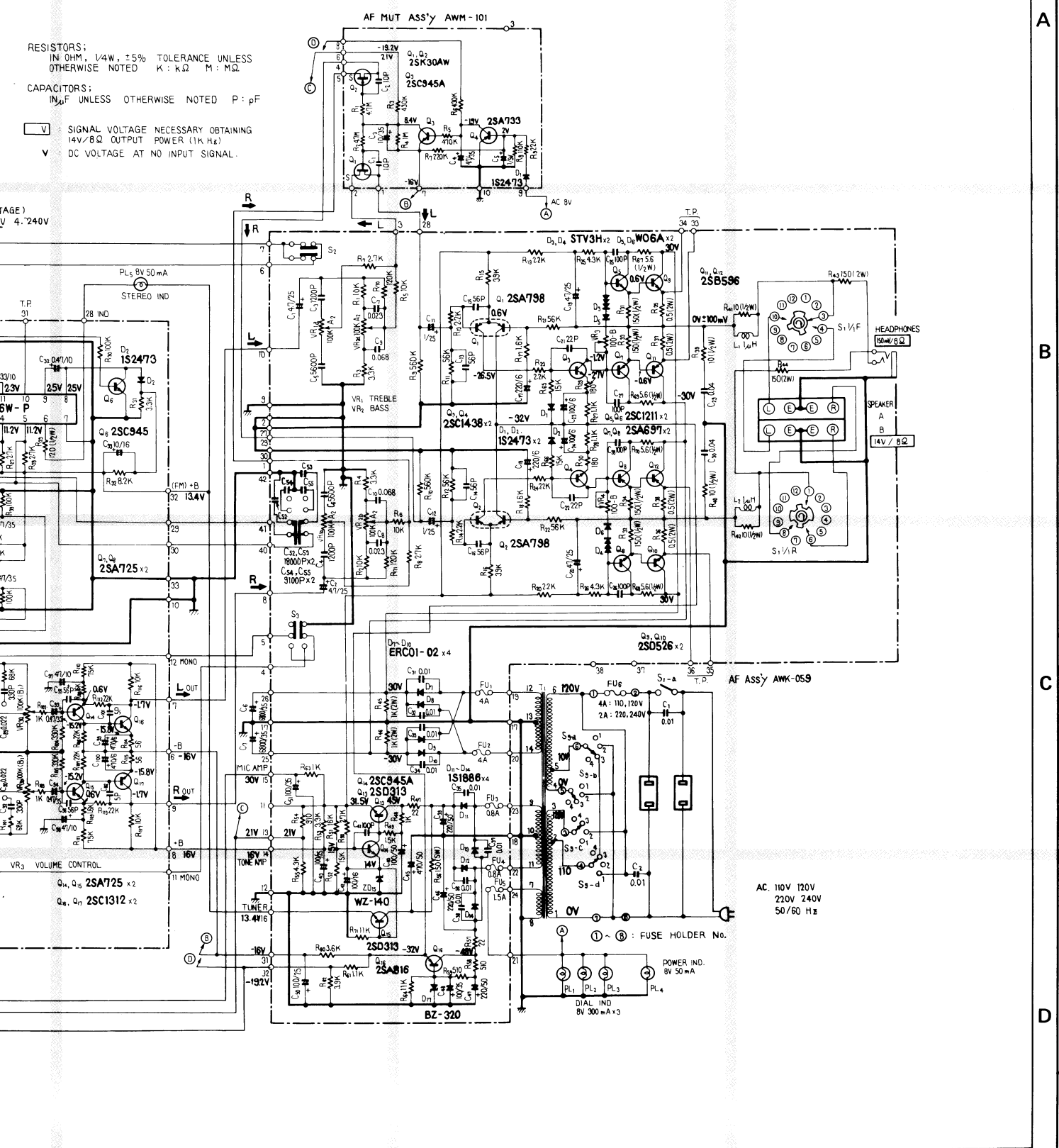

A

B

C

D

4

5

6

3,4 AF AMPLIFIER ASSEMBLY (AWK-059)

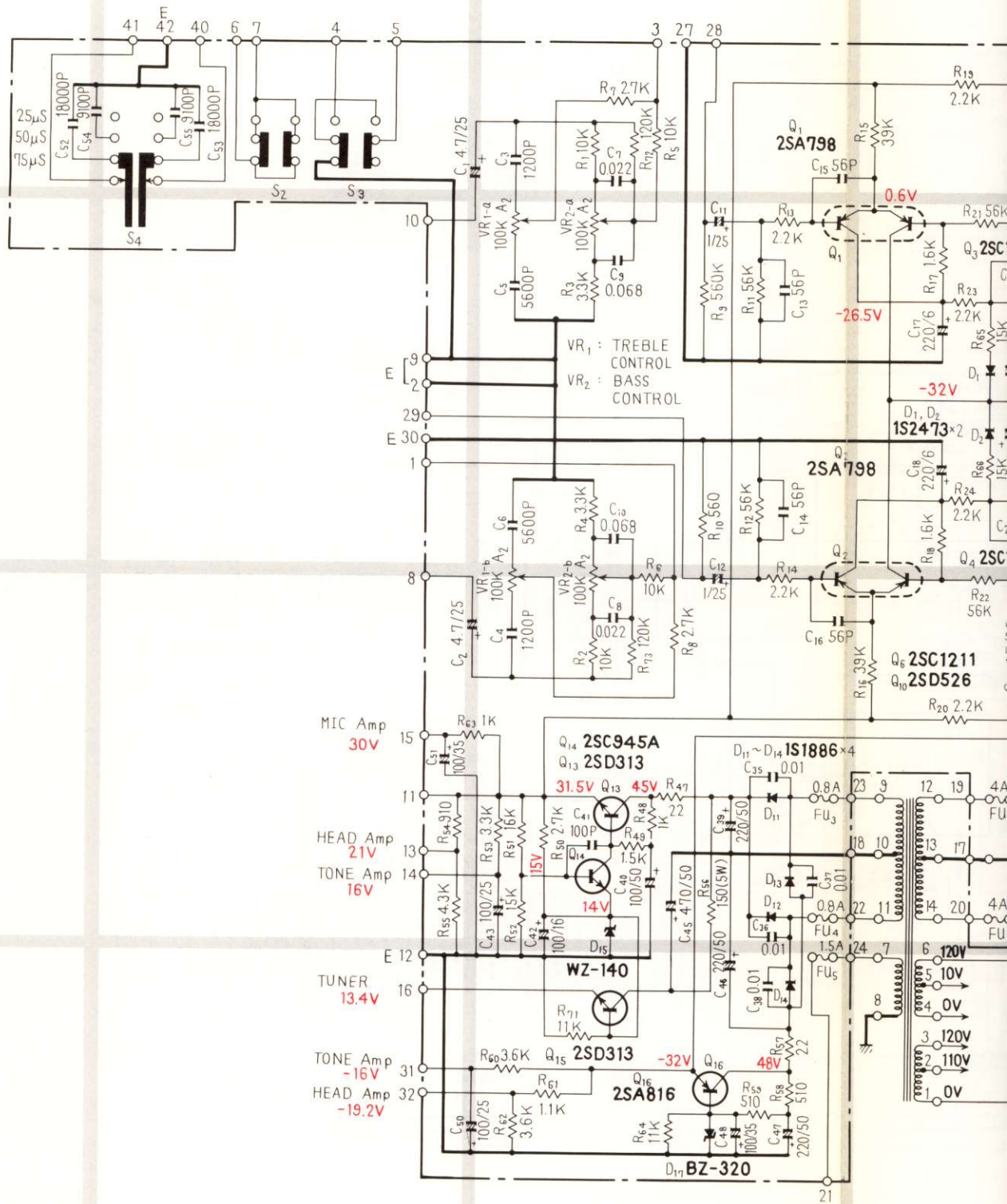

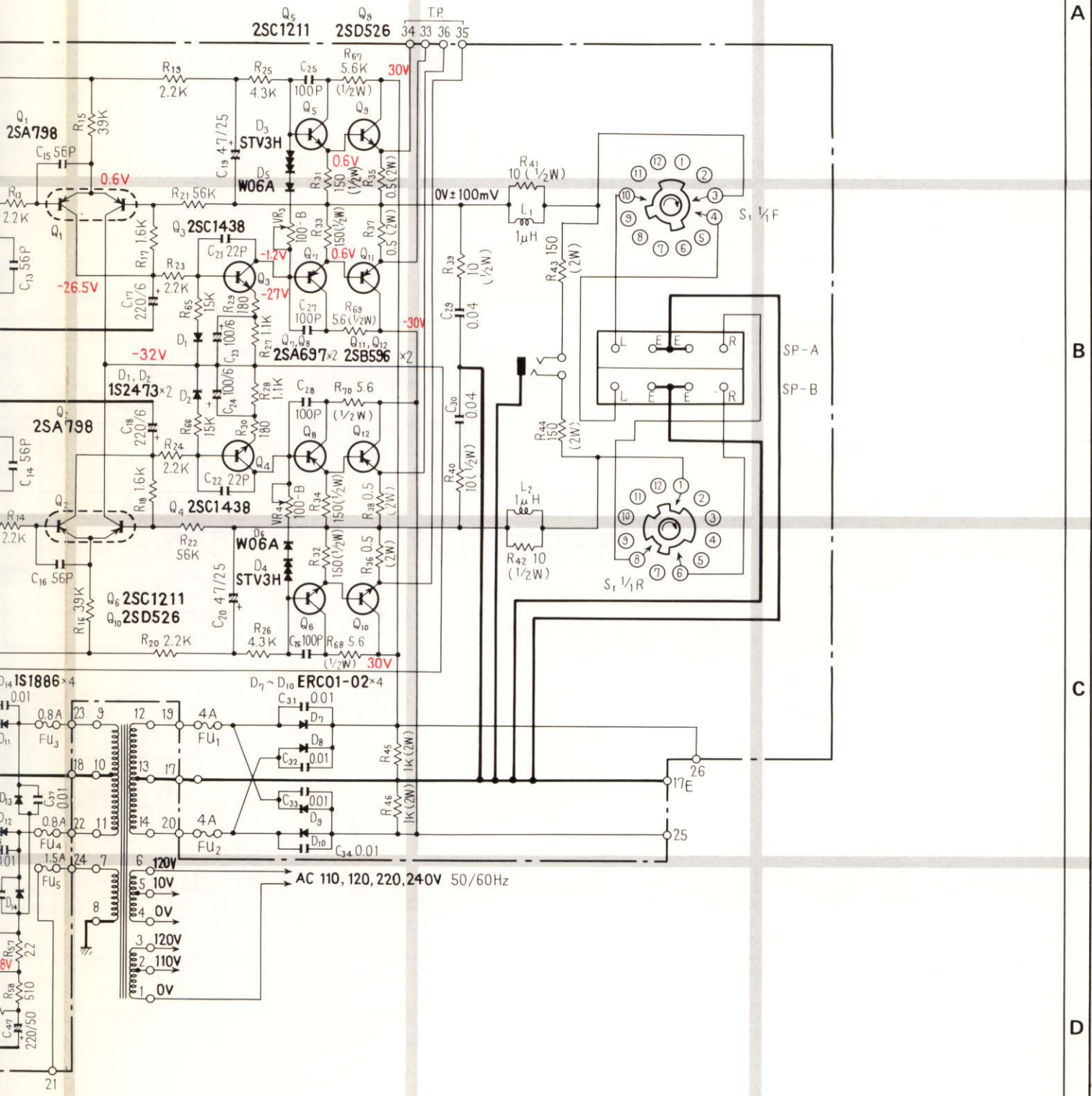

1

2

3

A

B

C

D

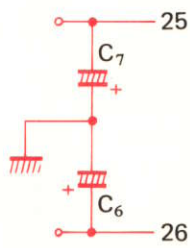
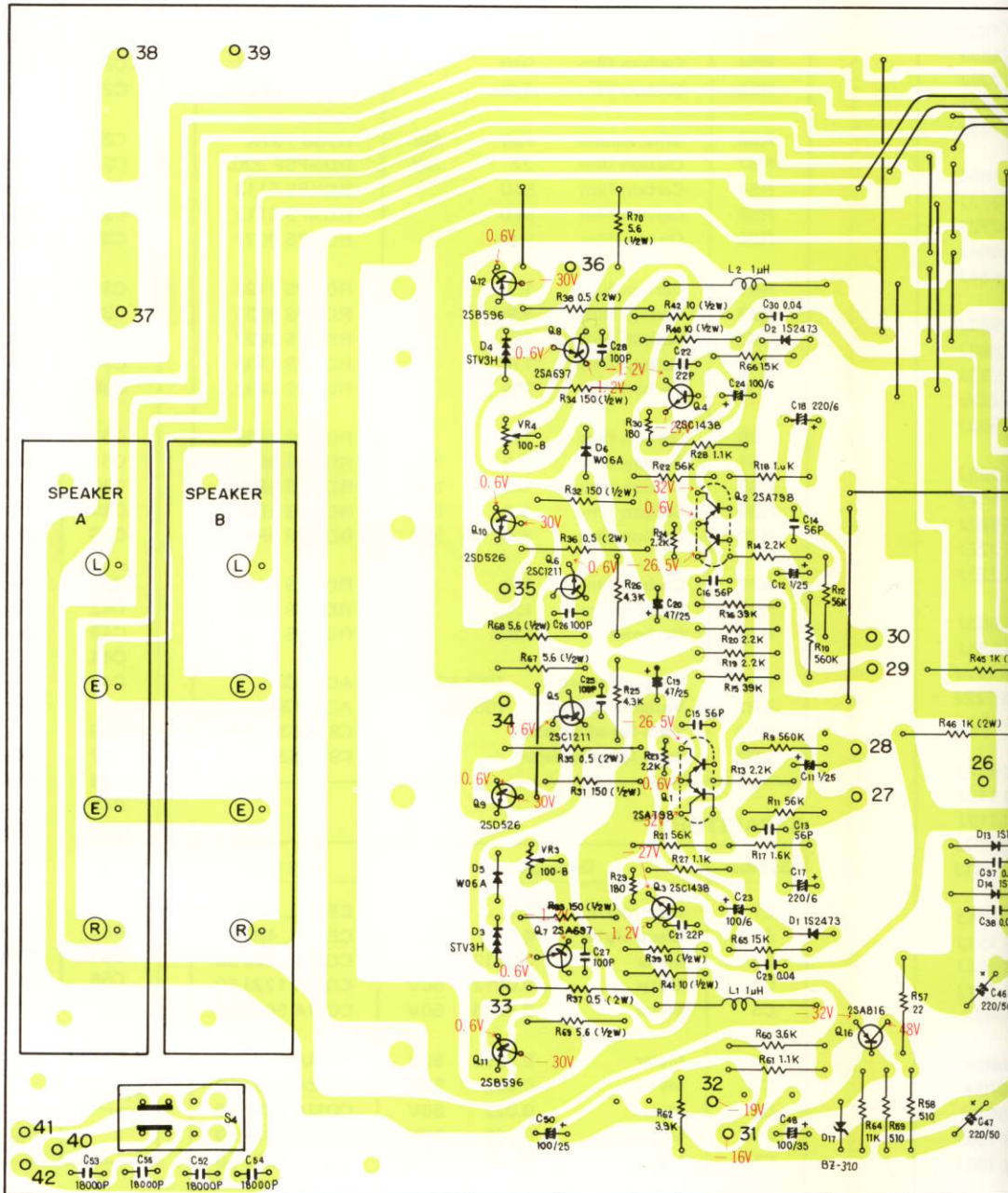

AWM-101 No.8 (-19.2V)

AWE-072 No.2 (-19.2V)

AWE-072 No.6 (-16V)

AWM-101 No.7 (-16V)

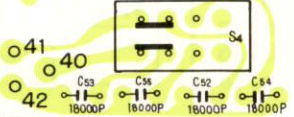

41 40
 AWE-072 No.30
 AWE-072 No.29

35 36 TP
 33 34 TP

AWM-101 No.1 28
 AWE-072 No.18, No.35
 AWE-072 No.8 (+16V)
 AWE-072 No.3 (+21V)
 AWM-101 No.6 (+21V)
 AWE-072 No.7

1

2

3

4

5

6

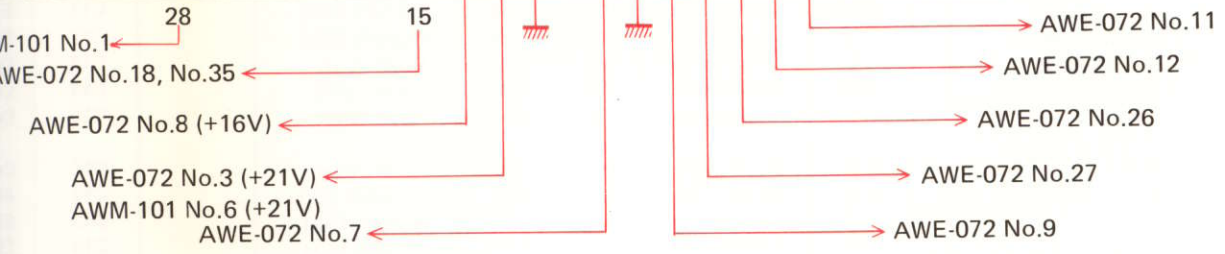
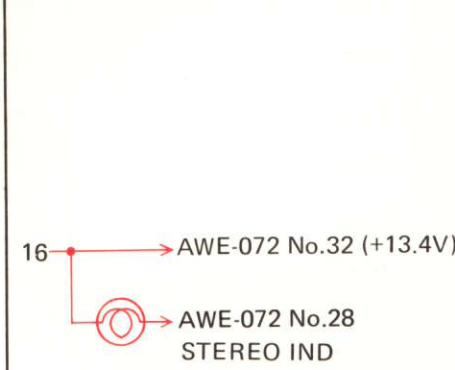
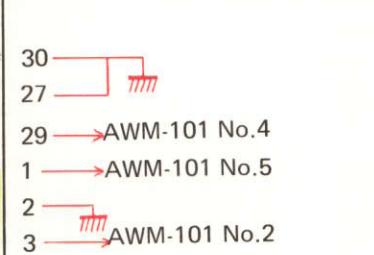
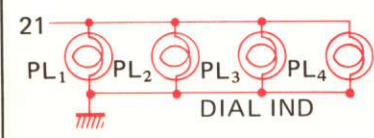
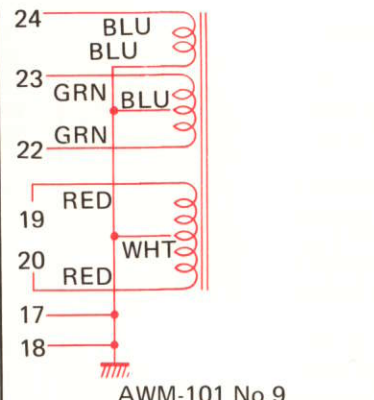
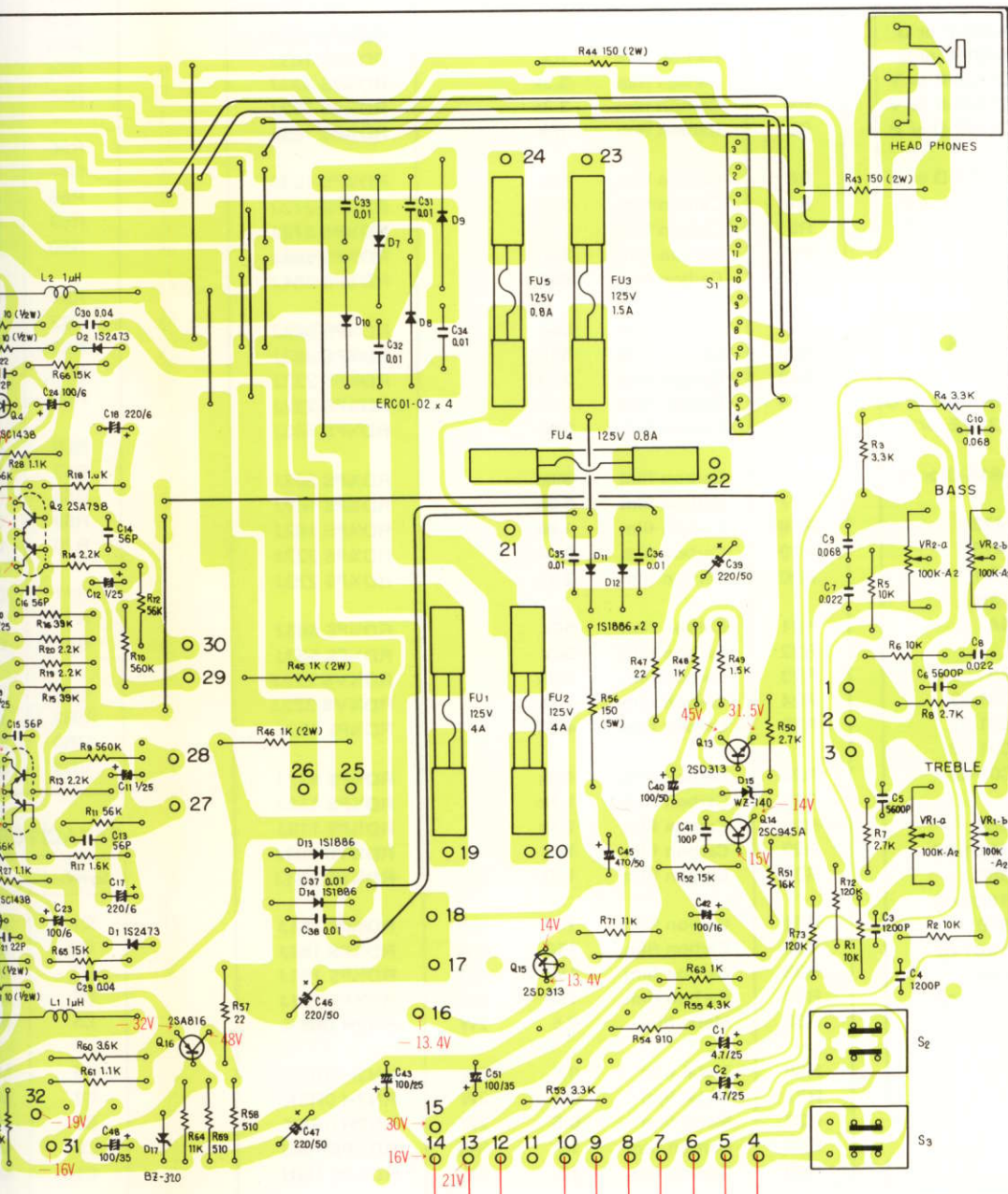

4

5

6

A
B
C
D

Parts List of AF Amplifier Assembly (AWK-059)

SEMICONDUCTORS

Symbol	Description	Part No.
Q1	Transistor	2SA798-F or G
Q2	Transistor	2SA798-F or G
Q3	Transistor	2SC1438-B or V
Q4	Transistor	2SC1438-B or V
Q5	Transistor	2SC1211-D or E
Q6	Transistor	2SC1211-D or E
Q7	Transistor	2SA697-D or E
Q8	Transistor	2SA697-D or E
Q9	Transistor	2SD526-O or Y
Q10	Transistor	2SD526-O or Y
Q11	Transistor	2SB596-O or Y
Q12	Transistor	2SB596-O or Y
Q13	Transistor	2SD313-E or D
Q14	Transistor	2SC945A-R or Q
Q15	Transistor	2SD313-E or D
Q16	Transistor	2SA816-O or Y
D1	Diode	1S2473
D2	Diode	1S2473
D3	Varistor	STV3H
D4	Varistor	STV3H
D5	Diode	W06A
D6	Diode	W06A
D7	Diode	ERC01-02
D8	Diode	ERC01-02
D9	Diode	ERC01-02
D10	Diode	ERC01-02
D11	Diode	1S1886 or S1B01-02
D12	Diode	1S1886 or S1B01-02
D13	Diode	1S1886 or S1B01-02
D14	Diode	1S1886 or S1B01-02
D15	Zener diode	WZ-140
D17	Zener diode	BZ-320

SWITCHES

Symbol	Description	Part No.
S1	Rotary switch	ASA-044
S2	Push switch	ASG-092
S4	Slide switch	ASH-017

COILS

Symbol	Description	Part No.
L1	Choke coil	ATH-011
L2	Choke coil	ATH-011

RESISTORS

Symbol	Description	Part No.
R1	Carbon film 10k	RD $\frac{1}{4}$ PS 103J
R2	Carbon film 10k	RD $\frac{1}{4}$ PS 103J
R3	Carbon film 3.3k	RD $\frac{1}{4}$ PS 332J
R4	Carbon film 3.3k	RD $\frac{1}{4}$ PS 332J
R5	Carbon film 10k	RD $\frac{1}{4}$ PS 103J
R6	Carbon film 10k	RD $\frac{1}{4}$ PS 103J
R7	Carbon film 2.7k	RD $\frac{1}{4}$ PS 272J
R8	Carbon film 2.7k	RD $\frac{1}{4}$ PS 272J
R9	Carbon film 560k	RD $\frac{1}{4}$ PS 564J
R10	Carbon film 560k	RD $\frac{1}{4}$ PS 564J
R11	Carbon film 56k	RD $\frac{1}{4}$ PS 563J
R12	Carbon film 56k	RD $\frac{1}{4}$ PS 563J
R13	Carbon film 2.2k	RD $\frac{1}{4}$ PS 222J
R14	Carbon film 2.2k	RD $\frac{1}{4}$ PS 222J
R15	Carbon film 39k	RD $\frac{1}{4}$ PS 393J
R16	Carbon film 39k	RD $\frac{1}{4}$ PS 393J
R17	Carbon film 1.6k	RD $\frac{1}{4}$ PS 162J
R18	Carbon film 1.6k	RD $\frac{1}{4}$ PS 162J
R19	Carbon film 2.2k	RD $\frac{1}{4}$ PS 222J
R20	Carbon film 2.2k	RD $\frac{1}{4}$ PS 222J
R21	Carbon film 56k	RD $\frac{1}{4}$ PS 563J
R22	Carbon film 56k	RD $\frac{1}{4}$ PS 563J
R23	Carbon film 2.2k	RD $\frac{1}{4}$ VS 222J
R24	Carbon film 2.2k	RD $\frac{1}{4}$ VS 222J
R25	Carbon film 4.3k	RD $\frac{1}{4}$ PS 432J
R26	Carbon film 4.3k	RD $\frac{1}{4}$ PS 432J
R27	Carbon film 1.1k	RD $\frac{1}{4}$ PS 112J
R28	Carbon film 1.1k	RD $\frac{1}{4}$ PS 112J
R29	Carbon film 180	RD $\frac{1}{4}$ VS 181J
R30	Carbon film 180	RD $\frac{1}{4}$ VS 181J
R31	Carbon film 150 $\frac{1}{4}$ W	RD $\frac{1}{4}$ PS 151J
R32	Carbon film 150 $\frac{1}{4}$ W	RD $\frac{1}{4}$ PS 151J
R33	Carbon film 150 $\frac{1}{4}$ W	RD $\frac{1}{4}$ PS 151J
R34	Carbon film 150 $\frac{1}{4}$ W	RD $\frac{1}{4}$ PS 151J
R35	Metal film 0.5 2W	RN2H 0R5K
R36	Metal film 0.5 2W	RN2H 0R5K
R37	Metal film 0.5 2W	RN2H 0R5K
R38	Metal film 0.5 2W	RN2H 0R5K
R39	Carbon film 10 $\frac{1}{4}$ W	RD $\frac{1}{4}$ PS 100J
R40	Carbon film 10 $\frac{1}{4}$ W	RD $\frac{1}{4}$ PS 100J
R41	Carbon film 10 $\frac{1}{4}$ W	RD $\frac{1}{4}$ PS 100J
R42	Carbon film 10 $\frac{1}{4}$ W	RD $\frac{1}{4}$ PS 100J
R43	Metal oxide 150 2W	RS2P 151K
R44	Metal oxide 150 2W	RS2P 151K
R45	Metal oxide 150 2W	RS2P 102K
R46	Metal oxide 1k 2W	RS2P 102K
R47	Carbon film 22 $\frac{1}{4}$ W	RD $\frac{1}{4}$ PSF 220J
R48	Carbon film 1k	RD $\frac{1}{4}$ PS 102J
R49	Carbon film 1.5k	RD $\frac{1}{4}$ PS 152J
R50	Carbon film 2.7k	RD $\frac{1}{4}$ PS 272J

Symbol	Description	Part No.
R51	Carbon film 16k	RD½PS 163J
R52	Carbon film 15k	RD½PS 153J
R53	Carbon film 3.3k	RD½PS 332J
R54	Carbon film 910	RD½PS 911J
R55	Carbon film 4.3k	RD½PS 432J
R56	Wire wound 750 5W	RT5B 751K
R57	Carbon film 22 ½W	RD½PSF 220J
R58	Carbon film 510	RD½PS 511J
R59	Carbon film 510	RD½PS 511J
R60	Carbon film 3.6k	RD½PS 362J
R61	Carbon film 1.1k	RD½PS 112J
R62	Carbon film 3.9k	RD½PS 392J
R63	Carbon film 1k	RD½PS 102J
R64	Carbon film 11k	RD½PS 113J
R65	Carbon film 15k	RD½PS 153J
R66	Carbon film 15k	RD½PS 153J
R67	Carbon film 5.6 ½W	RD½PS 5R6J
R68	Carbon film 5.6 ½W	RD½PS 5R6J
R69	Carbon film 5.6 ½W	RD½PS 5R6J
R70	Carbon film 5.6 ½W	RD½PS 5R6J
R71	Carbon film 11k	RD½PS 113J
R72	Carbon film 120k	RD½PS 124J
R73	Carbon film 120k	RD½PS 124J
VR1	Variable resistor 100KA2	ACV-138
VR2	Variable resistor 100KA2	ACV-138
VR3	Semi-fixed resistor	C92-063
VR4	Semi-fixed resistor	C92-063

CAPACITORS

Symbol	Description	Part No.
C1	Electrolytic 4.7 25V	CEANL 4R7P 25
C2	Electrolytic 4.7 25V	CEANL 4R7P 25
C3	Mylar 0.0012 50V	CQMA 122J 50
C4	Mylar 0.0012 50V	CQMA 122J 50
C5	Mylar 0.0056 50V	CQMA 562J 50
C6	Mylar 0.0056 50V	CQMA 562J 50
C7	Mylar 0.022 50V	CQMA 223J 50
C8	Mylar 0.022 50V	CQMA 223J 50
C9	Mylar 0.068 50V	CQMA 683J 50
C10	Mylar 0.068 50V	CQMA 683J 50
C11	Electrolytic 1 25V	CSZA 010M 25
C12	Electrolytic 1 25V	CSZA 010M 25
C13	Ceramic 56p 50V	CCDSL 560K 50
C14	Ceramic 56p 50V	CCDSL 560K 50
C15	Ceramic 56p 50V	CCDSL 560K 50
C16	Ceramic 56p 50V	CCDSL 560K 50
C17	Electrolytic 220 6V	CEA 221P 6
C18	Electrolytic 220 6V	CEA 221P 6
C19	Electrolytic 47 25V	CEA 470P 25
C20	Electrolytic 47 25V	CEA 470P 25

Symbol	Description	Part No.
C21	Ceramic 22p 50V	CCDSL 220K 50
C22	Ceramic 22p 50V	CCDSL 220K 50
C23	Electrolytic 100 6V	CEA 101P 6
C24	Electrolytic 100 6V	CEA 101P 6
C25	Ceramic 100p 50V	CCDSL 101K 50
C26	Ceramic 100p 50V	CCDSL 101K 50
C27	Ceramic 100p 50V	CCDSL 101K 50
C28	Ceramic 100p 50V	CCDSL 101K 50
C29	Ceramic 0.04 50V	CKDYF 403Z 50
C30	Ceramic 0.04 50V	CKDYF 403Z 50
C31	Ceramic 0.01 150V	ACG-004-0
C32	Ceramic 0.01 150V	ACG-004-0
C33	Ceramic 0.01 150V	ACG-004-0
C34	Ceramic 0.01 150V	ACG-004-0
C35	Ceramic 0.01 150V	ACG-004-0
C36	Ceramic 0.01 150V	ACG-004-0
C37	Ceramic 0.01 150V	ACG-004-0
C38	Ceramic 0.01 150V	ACG-004-0
C39	Electrolytic 220 50V	CEA 221P 50
C40	Electrolytic 100 50V	CEA 101P 50
C41	Ceramic 100p 50V	CCDSL 101K 50
C42	Electrolytic 100 16V	CEA 101P 16
C43	Electrolytic 100 25V	CEA 101P 25
C44
C45	Electrolytic 470 50V	CEA 471P 50
C46	Electrolytic 220 50V	CEA 221P 50
C47	Electrolytic 220 50V	CEA 221P 50
C48	Electrolytic 100 35V	CEA 101P 35
C49
C50	Electrolytic 100 25V	CEA 101P 25
C51	Electrolytic 100 35V	CEA 101P 35
C52	Mylar 0.018 50V	CQMA 183J 50
C53	Mylar 0.018 50V	CQMA 183J 50
C54	Mylar 0.0091 50V	CQMA 912J 50
C55	Mylar 0.0091 50V	CQMA 912J 50

OTHERS

Symbol	Description	Part No.
	Fuse clip	AKR-013

PIONEER ELECTRONIC CORPORATION

4-1, Meguro 1-Chome, Meguro-ku, Tokyo 153, Japan

U.S. PIONEER ELECTRONICS CORPORATION

75 Oxford Drive, Moonachie, New Jersey 07074, U.S.A.

PIONEER ELECTRONIC (EUROPE) N.V.

Luithagen-Haven 9, 2030 Antwerp, Belgium

PIONEER ELECTRONICS AUSTRALIA PTY. LTD.

178-184 Boundary Road, Braeside, Victoria 3195, Australia